

Professional Operator's Licence Information



For Tractor-Trailers,
Buses, Large Trucks,
Ambulances and Taxis

A supplement to the Basic Licence Driver's Handbook

Alberta

Table of Contents

CHAPTER 1

Commercial Operator's Licence Requirements

Upgrading your licence	4
Knowledge test.	5
Vision screening	5
Road test	6
Learning requirements	9
Licences: renewal and changes	9
Definitions	10

CHAPTER 2

Operating Class 1 Vehicles

Size and weight restrictions of commercial vehicles.....	14
Reporting to an inspection station.....	16
Vehicle inspections	17
Pre-trip inspection for tractor-trailer and semi-trailer.....	18
Air brake equipped vehicles.....	29
Components of the supply circuit of a CMVSS 121 air brake system	30
Primary brake circuit.....	31
Secondary brake circuit	32
The tractor-trailer air circuit.....	34
The brake chambers	35
Pre-trip air brake inspection.....	37
Air brake equipped farm vehicles.....	42
Rest and check stop inspections	42
End of trip inspection and report.....	44

Coupling and uncoupling a semi-trailer	44
Coupling and uncoupling pintle hitch attachments.....	45
Coupling mechanisms	47
Link-up arrangement	50
Operating long combination vehicles.....	51
Load security	53
Speed limits for long combination vehicles.....	54
Braking distance	54
Stopping distance.....	56
General braking information.....	57
Following distance between vehicles	58
Off-tracking	59
Turns	59
Curves	62
Parking	64
Backing (reversing).....	65
National Safety Code.....	70
Commercial Vehicle Inspection Program (CVIP).....	76

CHAPTER 3

Operating Buses

Information for Class 2 and Class 4 bus operators	81
Vehicle inspections	81
Pre-trip inspection	82
Post-trip inspection.....	88
Breakdowns	89
Passenger loading and unloading... ..	90

Railway crossing procedures for school bus operators	92
Reversing (backing)	94
Turnarounds	95
Parking on a hill.....	97
Discipline and problem solving.....	97
Safe driving guidelines.....	98
Improve your qualifications and knowledge.....	99

CHAPTER 4

Operating Class 3 Vehicles

Pre-trip inspection	103
Parking on a hill.....	110
Loading and unloading dump vehicle	111
Mixer truck operators	114

CHAPTER 5

Operating Class 4 Vehicles

Ambulance vehicles	117
Pre-trip inspection	118
Defensive driving factors.....	122
Operating a taxi	124
Pre-trip inspection	125
Fuelling a vehicle	129
Seat belts	129
Reserved lanes	129
For hire.....	130

CHAPTER 6

Transporting Dangerous Goods

What is a dangerous good?	132
Dangerous occurrences	138
Documents.....	139
Safety marks	139

CHAPTER 7

Transporting Persons with Disabilities

General rules for communicating..	143
General rules for driving	144
General rules for assisting a person with a wheelchair	144

CHAPTER 8

Railway Crossings, Fire and Fire Extinguishers, Fuelling a Vehicle

Railway crossings	148
Know the law	151
Fire and fire extinguishers.....	153
Fuelling a vehicle	156
Gasoline or diesel	156
Propane.....	157

Introduction

A message from Alberta Transportation

Being a professional driver involves more than just driving a different type of vehicle. It means taking pride in your work and being recognized as a professional driver.

As a professional driver you must always make sure you are mentally and physically fit to drive, your vehicle is well maintained and is in good working condition, and you drive within the law.

Always drive defensively. Be patient and tolerant of other drivers. Protect yourself, the vehicle, the passengers and the cargo. The more you can anticipate and avoid dangerous situations, the less likely you will be in a collision. Being involved in a collision may result in loss of income, job, health and possibly a life.

Remember that road safety is everyone's business.

Alberta Transportation

This handbook is also available on-line.

Web site: www.transportation.alberta.ca (under Drivers and Vehicles)

DATE: February 2009

This handbook, along with the *Basic Licence Driver's Handbook*, will give you the necessary information for learning to drive a truck, tractor-trailer, ambulance, taxi or bus. These two handbooks provide information that will help you obtain a professional Alberta operator's licence. We recommend that you enroll in driver training to supplement your knowledge and skill. You may want to keep a copy of these handbooks in the vehicle as a reference.

If further information is required regarding driver training schools or the driver examination process, please contact a Driver Programs Administrator at:

Edmonton 780-427-8901 or Calgary 403-297-6679
For toll-free service from anywhere in Alberta, call 310-0000.

This handbook is a guide only and has no legal authority. The laws that apply to driving a vehicle can be found in the *Traffic Safety Act* and its related regulations. This information is available from:

Queen's Printer Bookstore
Park Plaza Building
10611 – 98 Avenue
Edmonton, Alberta
T5K 2P7
780-427-4952

For toll-free service from anywhere in Alberta, call 310-0000.

These laws are also available on-line.

Web site: www.qp.gov.ab.ca/catalogue/index.cfm

Municipalities are given authority under the *Traffic Safety Act* to pass bylaws in areas such as speed zones, school zones, playground zones and parking. You must know local municipal by-laws.

Study this handbook carefully. Enjoy being a safe driver.

Chapter 1

Commercial Operator's Licence Requirements

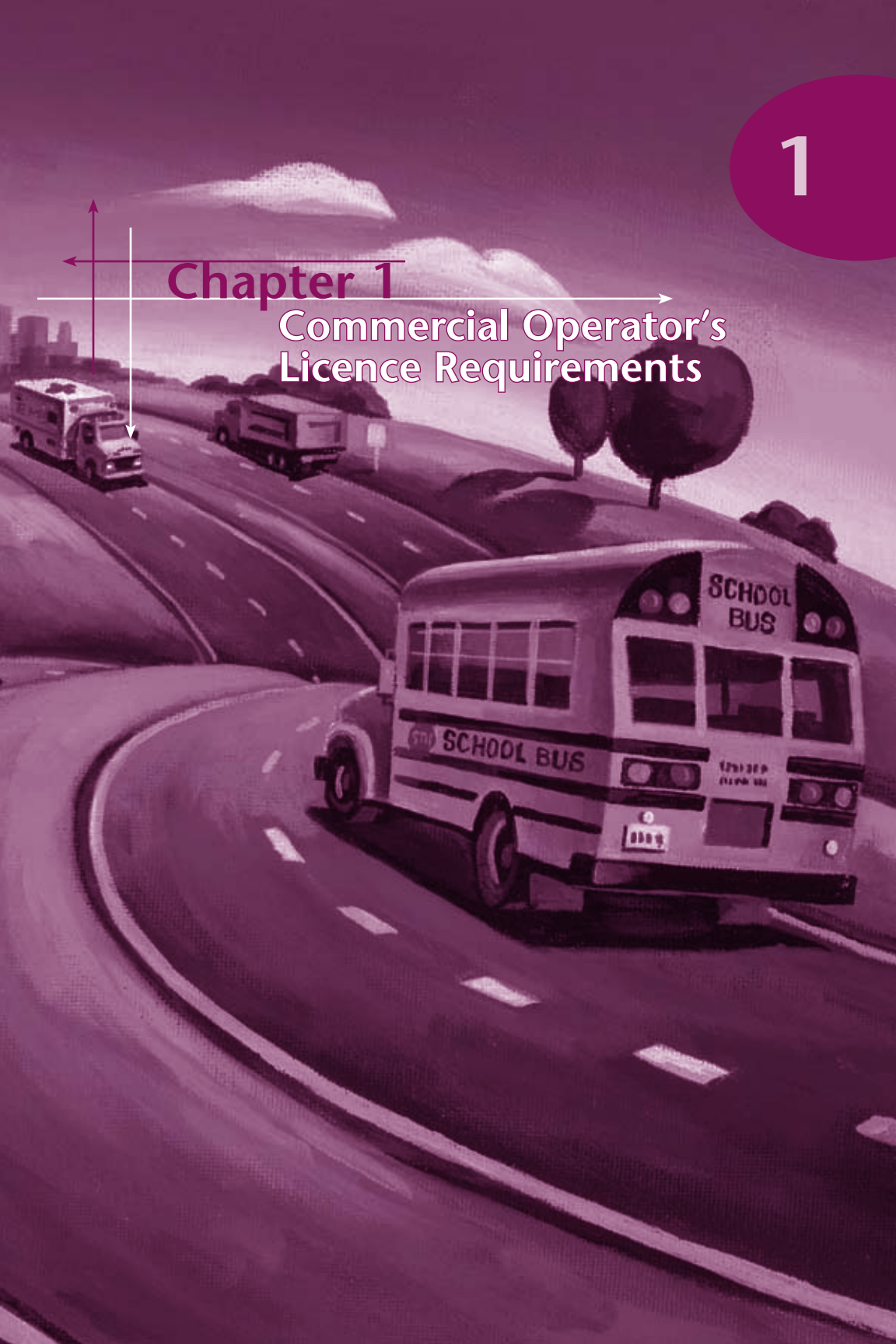

1

Commercial Operator's Licence Requirements

Information about the different Alberta operator's licence classes, and the vehicles that can be operated in each class, can be found in the *Basic Licence Driver's Handbook*. All handbooks are available from any Registry Agent office or on-line at Alberta Transportation's web site at: www.infra.gov.ab.ca. To locate a Registry Agent in your area, please refer to the local telephone SuperPages under Licence and Registry Services. You can also check on-line at: www.servicealberta.gov.ab.ca/ra/ran.cfm

Upgrading your licence

The following information is specific for upgrading an operator's licence to the professional classes.

General information for Classes 1, 2, 3 and 4

- The minimum learning or licensing age for these classes is 18 years. To learn to drive a professional class vehicle, you must have at least a Class 5 or a Class 5 Graduated Driver Licensing Program (GDL) operator's licence. You may not apply for any professional class of operator's licence if you are a probationary driver under the Graduated Driver Licensing Program.
- You do not need an air brake endorsement when learning to operate a vehicle that is equipped with air brakes.
- A medical report is required to upgrade to a Class 1, 2 or 4 licence.
 - * Medical forms are available from a Registry Agent or a doctor. A doctor must complete this form.

- * A medical report is required when first applying for a licence and:
 - every 5 years after that, until 45 years of age
 - every 2 years from age 45 to 65
 - every year after you turn age 65.
- * You are legally responsible to report any disease or disability that may interfere with the safe operation of a motor vehicle to any Alberta Registry Agent office.
- * Alberta Registries can request a medical report from any driver, in any licence class, if they have concerns about a driver’s medical condition.
- A fee is charged for each knowledge test, road test, and operator’s licence re-classification. For information regarding current fees, contact any Registry Agent office or driver examiner.
- A 10-day waiting period is required for all non-GDL Class 5, 5-6 and 6 new applicants from other Canadian jurisdictions who want to re-class to licence Classes 1 to 4. This waiting period is required for Alberta to confirm the applicant’s licence information.
- Driving with the wrong licence class is against the law. It is also an offence for a vehicle’s owner to allow the vehicle to be driven by someone who does not have the proper class of licence to drive that vehicle.

Knowledge test

To upgrade an operator’s licence, you will need to pass a knowledge test for the class of licence for which you are applying. The test questions are based on information from this handbook and from the *Basic Licence Driver’s Handbook*.

Vision screening

A vision screening is required before upgrading your Alberta operator’s licence. If you do not meet the minimum vision standards, you will be referred to an eye specialist. If you have corrective glasses or contact lenses, bring them to the vision screening.

1

Road test

If you are applying for a commercial licence in the Class 1, 2 or 3 categories, you will be required to conduct a pre-trip inspection in addition to the road test. You must communicate and demonstrate to the driver examiner:

- a pre-trip inspection of the vehicle
- the appropriate uncouple/couple procedures for Class 1 vehicles
- an in-cab inspection of the vehicle's air brake system for units equipped with air brakes.

As part of communicating and demonstrating, you should point to the things you are inspecting and tell the examiner what you are looking at. For example, you could say, "I am checking the left signal light to see that it is working, is securely mounted, and that the lens is clean and not cracked."

This handbook includes different pre-trip inspections for the various types of vehicles. Study and practice the pre-trip that is appropriate for the class of licence you are working towards. The procedures in this handbook are only guidelines to follow during a road test. A vehicle may require different items to be checked than those listed.

Each pre-trip inspection and road test is allowed a certain amount of time. You should be able to complete the inspection and road test within that time.

If a vehicle does not pass the pre-trip inspection, or you do not successfully complete the pre-trip inspection, the road test will not proceed.

An applicant who holds a Graduated Driver Licence (GDL) may not take a road test for a licence classification higher than a Class 5.

Note: A road test will not be done in a vehicle that is required to display dangerous goods placards.

Class 1

- For a road test, you must provide a tractor-trailer combination with three or more axles, and the trailer must be equipped with a pure air brake system to its foundation brakes. You must show proof of your air brake “Q” endorsement or a course completion certificate from an approved air brake delivery agent. This includes drivers of farm vehicles registered as tractor-trailers.
- The examiner must see your road test permit. Permits can be purchased from most Registry Agents.
- A Class 1 licence may not be obtained without the driver first having qualified for an air brake endorsement. The actual “Q” endorsement does not appear on the Class 1 licence. However, it must appear on licences for other classes that require the operation of air brake equipped vehicles.

Class 2

- For a road test, you must provide a bus with a seating capacity exceeding 24 passengers, excluding the driver. If the vehicle is equipped with air brakes, you must have either an air brake “Q” endorsement or a course completion certificate from an approved air brake delivery agent.
- The examiner must see your road test permit. Permits can be purchased from most Registry Agents.

Note: When learning in a bus, you are permitted to have only the instructor in the vehicle.

1

Class 3

- For a road test, you must provide a single motor vehicle that has three or more axles. Three axle recreational vehicles may not be used. If the vehicle provided for the road test is equipped with air brakes, you must have either an air brake “Q” endorsement or a course completion certificate from an approved air brake delivery agent.

Note: Drivers of single motor vehicles registered as farm vehicles do not require an air brake “Q” endorsement.

- The examiner must see your road test permit. Permits can be purchased from most Registry Agents.

Class 4

- For a road test, you must provide a Class 5 vehicle or a bus with a seating capacity not exceeding 24 passengers, excluding the driver. If the vehicle is equipped with air brakes, the applicant must have either an air brake “Q” endorsement or a course completion certificate from an approved air brake delivery agent.
- The examiner must see your road test permit. Permits can be purchased from most Registry Agents.

Note: When learning in a bus, you are permitted to have only the instructor in the vehicle. Class 5 vehicles are also suitable for learning.

Recommended Licensing Sequence

- It is strongly recommended that the road test be the final component in the licensing process. Any required knowledge test, vision screening, medical report and/or air brake course should be completed prior to the road test.

Learning requirements – Classes 1, 2, 3 and 4

Desired Licence Class	Class Needed for Learning	Minimum Licensing Age	Minimum Learning Age	Accompanied by Instructor	Minimum Age for Instructor	Instructor Requires Class	Minimum Age to Take Road Test
1	2, 3, 4, 5 or 5-GDL*	18	18	Yes	18	1	18 non-GDL*
2	3, 4, 5 or 5-GDL*	18	18	Yes	18	1 or 2	18 non-GDL*
3	4, 5 or 5-GDL*	18	18	Yes	18	1, 2 or 3	18 non-GDL*
4	3, 5 or 5-GDL*	18	18	Yes	18	1, 2 or 4	18 non-GDL*

* GDL – Graduated Driver Licence (Probationary)

Licences: renewal and changes

It is your responsibility to renew your operator's licence on or before the expiry date. A licence renewal application will be mailed before the expiry date to your last registered address. If you do not receive your application, you must go to a Registry Agent office.

1

To change a name or address on your operator's licence, visit any Registry Agent. By law, a person is required to notify Alberta Registries, through a Registry Agent, of any name or address change immediately. Proper identification is required before any change, replacement or renewal can be made.

Definitions

Air brakes (air to all foundation brakes)

A vehicle with an air brake system has brakes that are initiated by air pressure from an engine-driven compressor. This sends air pressure through a series of hoses, reservoirs and control valves to all the vehicle's foundation brakes. An air brake "Q" endorsement or Class 1 licence is required to drive a vehicle with an air brake system.

Air over hydraulic braking system (combination of air and hydraulic foundation brakes)

In an air over hydraulic braking system the vehicle's axles have air actuated foundation brakes, and some of the vehicle's axles have hydraulic foundation brakes. An air brake "Q" endorsement or Class 1 licence is required to drive this type of vehicle.

Air actuated hydraulic braking system (air assisted, but all foundation brakes are hydraulic)

In an air actuated hydraulic braking system the air compressor is used to boost the hydraulic system to all the vehicle's foundation brakes. An air brake "Q" endorsement is **not** required to drive this type of vehicle.

Note: No drivers may operate a vehicle equipped with air brakes (air to all foundation brakes) unless they hold either a Class 1 operator's licence or an operator's licence with a "Q" (air brake) endorsement.

Ambulance

An ambulance is an emergency vehicle that is designed to transport injured persons, and is equipped with rescue or first aid equipment.

Axle

An axle is a shaft on which two or more wheels revolve.

Bus

A bus is a motor vehicle that is:

- designed for carrying 11 or more persons, including the person driving the vehicle (TSA section 130(1)(i))
- registered as a school bus or kindergarten bus. A school bus means a motor vehicle used primarily for transporting people to and from a school
- registered as a commercial bus.

1

“Q” Endorsement

A “Q” endorsement is placed on any class of operator’s licence, except Class 1, when a driver successfully completes an approved Alberta air brake course through an authorized agency. Since it is not possible to get a Class 1 licence without the driver first having qualified for an air brake endorsement, the actual “Q” endorsement will not appear on the Class 1 licence. For information on taking an approved air brake course, please contact a Driver Programs Administrator at:

Edmonton 780-427-8901 or Calgary 403-297-6679

For toll-free service from anywhere in Alberta, dial 310-0000.

Chapter 2

Operating Class 1 Vehicles

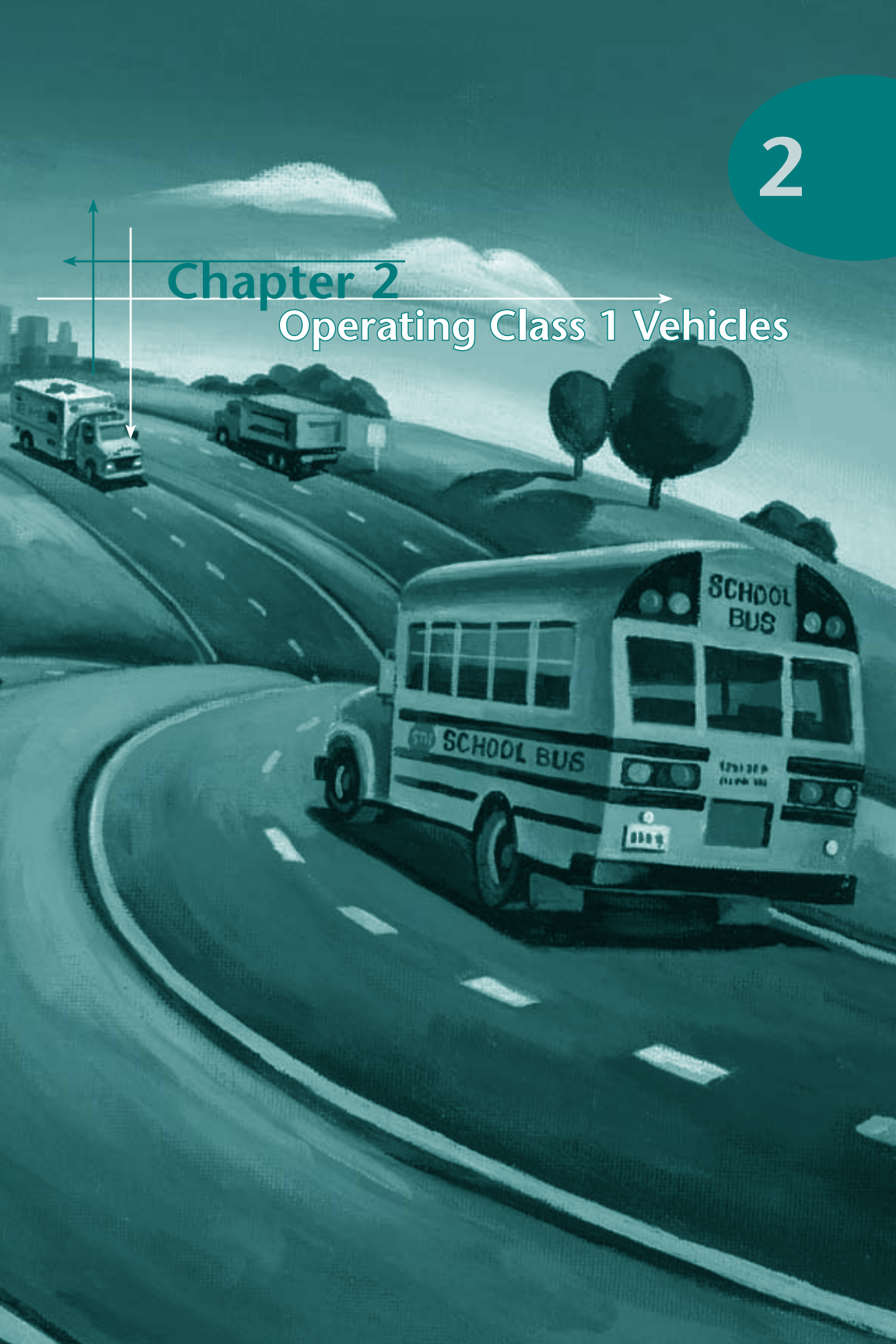

2

Operating Class 1 Vehicles

Operating a truck-tractor and semi-trailer

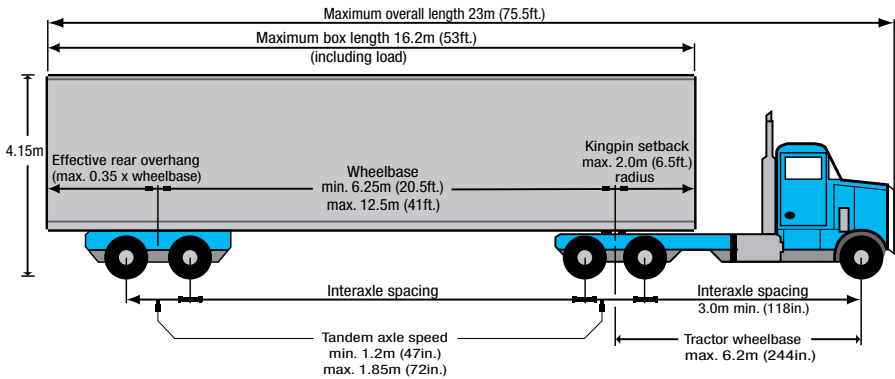

The holder of a Class 1 operator's licence may operate:

- any motor vehicle or combination of vehicles other than a motorcycle
- a Class 6 type vehicle (motorcycle) for learning only.

Size and weight restrictions of commercial vehicles

Commercial vehicles must not be more than the following dimensions.

- 2.6 metres in width. If the vehicle is wider than 2.05 metres, clearance lights are required. These must be amber in the front and red in the rear
- 4.15 metres in height off the ground surface
- 12.5 metres in length for a single vehicle
- 6.2 metres in wheelbase length for a truck-tractor (if the vehicle was constructed on or after November 15, 1988)

- 20 metres in overall length for a truck-tractor and semi-trailer combination (if the vehicle was constructed prior to November 15, 1988 and qualifies for the transitional dimensions)
- 23 metres in overall length for a tractor semi-trailer or truck and towed trailer combination
- 23 metres in overall length for a truck-tractor and double trailer combination (if the vehicle was constructed prior to November 15, 1988 and qualifies for the transitional dimensions)
- 25 metres in overall length for Transportation Association of Canada (TAC) vehicle combinations including A, B and C trains.

No vehicle or combination of vehicles will be allowed to operate on a highway if the weight on a tire, axle or axle groups or gross weight is more than what is allowed under the *Commercial Vehicle Dimensions and Weight Regulation (AR 315/2003)*.

Specialized, oversized or overweight equipment requires a special permit. The permit will have specific conditions on it. These conditions will state:

- the routes you may travel on
- the days and hours of travel
- the type of equipment that must be used
- anything else that is needed to prevent road damage and to ensure safety.

For more information or to apply for a permit, contact the Central Permit Office at 1-800-662-7138 (within Alberta) or 403-342-7138 (from outside Alberta) or your nearest Alberta Transportation Vehicle Inspection Station. Clients using cell phones can dial toll-free using Telus or Bell #310 or Rogers AT & T *310.

2

If a vehicle's load reaches or extends more than 1.5 metres beyond the rear of the vehicle, the following is required.

- During daylight hours, a red flag, not less than 30 centimetres square, must be attached to the end of the extension.
- During nighttime hours, a red light must be attached to the end of the extension.

Reporting to a vehicle inspection station

Commercial vehicles with a gross vehicle weight (GVW) of 4,500 kilograms or more must report to a vehicle inspection station when required, as indicated by a sign and flashing lights.

Vehicle inspections

A vehicle inspection will identify systems or parts of a vehicle that:

- are not working properly
- have failed
- are missing components.

Why are inspections necessary?

The basic reasons for conducting pre-trip, en-route and post-trip inspections are the following.

- Safety is the first priority. An inspection can help avoid mechanical defects or malfunctions that increase the likelihood of a collision or downtime.
- Skipped or poorly conducted inspections can be very costly. Inspections that are done well help to reduce maintenance costs by uncovering small problems before they become large ones.

Inspections that are regulatory (compliance)

There are federal and provincial laws that mandate inspections. The *Alberta Commercial Vehicle Maintenance Standards Regulation (AR 118/89)* states:

Inspections

3. (1) *The driver of a commercial vehicle shall inspect it prior to operating it at the beginning of a work shift and after he ceases to operate it at the end of a work shift.*

2

(2) *An inspection carried out under subsection (1) must include an inspection of the following equipment:*

- (a) the lighting devices and reflectors*
- (b) the tires*
- (c) the coupling devices*
- (d) the wheels and rims*
- (e) the service brake, including the trailer brake connections*
- (f) the parking brake*
- (g) the steering mechanism*
- (h) the horn*
- (i) the windshield wipers*
- (j) the rear vision mirrors, and*
- (k) the emergency equipment.*

Report by driver

4. *A driver of a commercial vehicle shall inform the carrier responsible for that vehicle of any defects or deficiency that would affect the safe operation of the vehicle.*

There are vehicle inspectors throughout the province who conduct commercial vehicle inspections. Vehicles that do not meet the requirements can be taken out-of-service until the repairs are made. This can also result in fines and points assessed on the Carrier Profile.

Pre-trip inspection for a truck-tractor and semi-trailer

The following detailed pre-trip inspection is a guide for reference only. Check with your employer to determine if the company has its own forms for recording vehicle condition reports.

Remember that a vehicle pre-trip inspection is required as part of the road test when applying for a Class 1 operator's licence.

Before beginning the inspection

- Choose terrain that is as level as possible and park the vehicle safely away from traffic.
- Set parking/spring brake. Place the transmission in low gear for a manual or in park for an automatic.
- Shut off the engine.
- Block the wheels. Ensure that the blocks will keep the vehicle from moving when the air brakes are released later.

Circle check for a truck-tractor and semi-trailer

The drawing shows one way to make a full circle check. Do a walk-around check before starting any trip. The circle check may be done in any order, but make sure that you check everything and always make a complete circle around the vehicle.

Reminder: Before starting a check, make sure the wheels are blocked and apply the parking brake.

Daily walk-around procedure – items to check

Starting at the front of the vehicle and going down the left side of the vehicle, from the front to the back, facing the direction of an approaching vehicle, check the following.

2

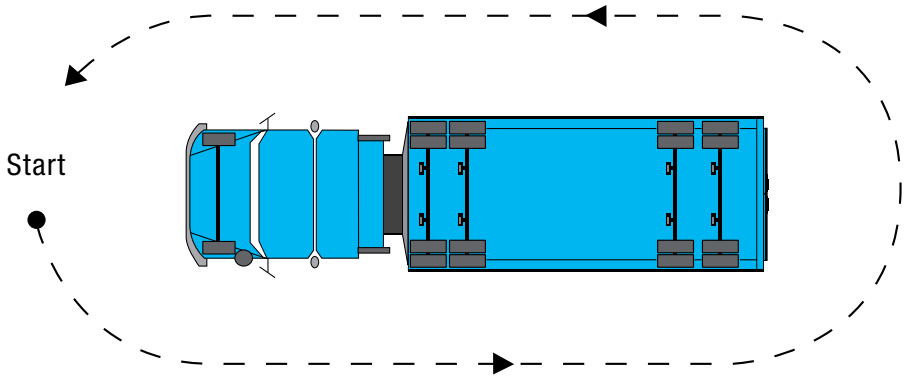

Outside of the vehicle

Under the hood

- radiator has no leaks, has adequate coolant level and proper fitting cap
- fan has no bent, cracked, missing blades or loose mountings
- all belts have correct tension and do not show signs of wear
- oil and other fluid levels are adequate
- air filter for condition
- all hose connections are secure, have no leaks, kinks, cuts, abrasions or cracks
- air compressor is securely mounted, condition of lines, fittings, hoses and couplers
- shock absorbers are not loose or leaking
- suspension has no cracked, missing or broken leaf springs, or U-bolts that are loose, broken or missing
- steering system has no bent, broken or missing parts, power steering pump and hose for leaks and adequate fluid level, steering mechanism has no wear or excessive play.

Steering axle brakes, check

- brake chambers for condition and security
- slack adjuster angle, push rod travel, mechanical condition and wear
- air lines have no leaks, kinks, cuts, abrasions or cracks.

Front of vehicle

- no traces of leaking fluids on the ground under the vehicle
- licence plate is valid, clean and secure
- high and low beam headlights work, lenses are clean and not cracked
- hazard warning lights work, lenses are clean and not cracked
- right and left turn signals work, lenses are clean and not cracked
- clearance and marker lights work, lenses are clean and not cracked, and reflectors are clean.

2

Left side of the tractor area

- steering axle tire has adequate tread depth, proper inflation, no bulges, sidewall separation, cuts or uneven wear
- steering axle rim has no cracks, missing pieces, bends or rust streaks, wheel fasteners are secure and not missing, broken or loose
- oil level in steering axle wheel bearing if equipped
- inspection decal is present, valid and in the proper location
- driver's door operates properly
- handrail is secure
- steps are secure and in good condition
- mirrors are attached securely and not cracked
- fuel tank has no leaks, tank is secure, the air vent is not plugged and the proper fitting cap is secure
- battery has no cracks, excessive corrosion or leaks, terminal connections are secure, battery is securely mounted (battery location may vary on each vehicle)
- fuel system lines are secure and have no leaks
- exhaust system is in good condition, has no leaks, muffler is securely attached, and the heat shield (if present) is secure
- storage compartment doors open and close properly and contents are secure
- first drive axle tires have adequate tread depth, proper inflation, no bulges, sidewall separation, cuts or uneven wear, dual tires are not touching and nothing is trapped between them

- first drive axle wheel rims have no cracks, missing pieces, bends or rust streaks, wheel fasteners are secure and not missing or broken
- second drive axle tires have adequate tread depth, proper inflation, no bulges, sidewall separation, cuts or uneven wear, dual tires are not touching and nothing is trapped between them
- second drive axle wheel rims have no cracks, missing pieces, bends or rust streaks, wheel fasteners are secure and not missing, broken or loose
- fifth wheel coupler bolt is secure, slider is locked and secure, plate shows no damage, cracks or weld separations, plate is flush to the apron (no daylight is visible between them)
- fifth wheel locking jaws are closed, plate sits flat on the underside of trailer, kingpin is enclosed
- kingpin and pintle hitch eyehook (if equipped) is not worn, damaged, cracked or broken
- hitches (if equipped), pintle hitch or ball hitch is not worn and locking mechanism is closed
- chains, cables (if equipped) have no stress cracks or weld breaks and are securely attached
- drive shaft for condition and there are no obstructions
- suspension has no cracked, missing or broken springs, torsion bars or walking beams are secure and not damaged, no loose, missing, or broken U-bolts, shock absorbers are securely mounted and not leaking. If a vehicle has air suspension, check for damaged, worn or inoperative air bags
- axle assembly has no breaks, cracks, holes, broken seals or bends
- signal lights work, lenses are clean and not cracked

2

- brake lights work, lenses are clean and not cracked (whenever possible, have another person activate the brakes while you check for proper operation)
- backing and docking lights work, lenses are clean and not cracked (whenever possible, have another person activate the controls while you check for proper operation)
- brake chambers are secure, no signs of cracks, corrosion or holes and nothing obstructs the push rod travel
- slack adjusters - pull manually or use a pry bar to check for travel, mechanical condition and wear
- air lines are secured, no leaks, kinks, cuts, abrasions or cracks in housing
- mud flap is secure and does not rub tires
- body has no damage, broken or missing rivets, holes or weld separations.

Left front and side of trailer

- body has no damage, broken or missing rivets, holes or weld separations
- frame and structural supports have no holes, bends, cracks, weld separations or broken cross members
- landing gear is raised, handle is secure, there are no cracks or breaks in cross members or webbing, lowering mechanism is secure
- air lines are secured safely, there are no leaks, kinks, cuts, abrasions or cracks in housing
- clearance and marker lights work, lenses are clean and not cracked, reflectors and retro-reflective tape are clean

- ❑ load security devices work, anchor points are secure, vehicle and load devices are not damaged
- ❑ first trailer axle tires have adequate tread depth, proper inflation, no bulges, sidewall separation, cuts or uneven wear, dual tires are not touching and nothing is trapped between them
- ❑ first trailer axle wheel rims have no cracks, missing pieces, bends or rust streaks, wheel fasteners are secure and not missing or broken
- ❑ second trailer axle tires have adequate tread depth, proper inflation, no bulges, sidewall separation, cuts or uneven wear, dual tires are not touching and nothing is trapped between them
- ❑ second trailer axle wheel rims have no cracks, missing pieces, bends or rust streaks, wheel fasteners are secure and not missing, broken or loose
- ❑ sliding tandem and locking pin - the pin is locked and secure, no bends, cracks, breaks or weld separations in the cross members, torsion bars or flanges
- ❑ brake chambers are secure, have no cracks or corrosion, and nothing will obstruct the push rod travel
- ❑ all slack adjusters - pull manually or use a pry bar to check for travel, mechanical condition and wear
- ❑ suspension has no cracked, missing or broken springs, torsion bars or walking beams are secure and not damaged, no loose, missing or broken U-bolts. If the trailer has air suspension, check for damaged, worn or inoperative air bags
- ❑ axle assembly has no breaks, cracks, holes or cracked seals.

2

Rear of trailer

- right and left turn signals work, lenses are clean and not cracked
- hazard warning lights work, lenses are clean and not cracked
- brake lights work, lenses are clean and not cracked (whenever possible, have another person activate the brakes while you check for proper operation)
- clearance and marker lights work, lenses are clean and not cracked, reflectors and retro-reflective tape are clean
- licence plate is clean, attached securely, the registration decal is valid, licence plate light is secure and works, and the lens is clean
- trailer doors or gates work, are closed and secure
- mud flaps are secure and do not rub on the tires.

Right side of truck-tractor and semi-trailer

Continue inspecting the right side of the unit using the same procedures as on the left side of the truck-tractor and semi-trailer.

In the cab and engine start up

- seat and mirrors are adjusted properly
- seat belt is adjusted and fastened properly
- feel and operation of brake pedal and clutch pedal (if equipped)
- steering has no excessive play or slack
- all gauges and warning lights work
- fuel level is adequate
- windows are clean, windshield is clean and free of major cracks
- windshield wipers work, washer has adequate fluid and sprays well
- defroster and heater work properly
- horn works.
- engine runs smoothly
- hand throttle and accelerator pedal operate properly
- air pressure build-up time is adequate and the air pressure drop does not exceed an acceptable amount when the brakes are applied
- there is no unusual noise when the clutch is pushed in and released while the transmission is in neutral for a manual transmission.

2

Extra equipment and documentation

- fire extinguisher is fully charged and label shows that it has not expired, and approved warning devices are present
- first aid kit is fully equipped
- all necessary documentation is in the vehicle. This includes the vehicle registration and valid insurance, Commercial Vehicle Inspection Program (CVIP) inspection certificate, any necessary operating authorities, permits and logbook, if required, are valid
- all personal protective equipment that is required before going on a work site is present
- tools are properly secured
- spare light bulbs, fuses, belts and other required parts are present.

Air brake equipped vehicles

How air supplies braking force

Compressed air is air that has been forced into a small space. Compressed air has a higher temperature and pressure than decompressed air. If channelled or directed properly, compressed air will cause or exert a great force or pressure. This directed force makes an air brake system work.

Force can be generated by applying pressurized air to the diaphragm of a brake chamber. The amount of force generated by the brake chamber depends upon:

- Brake chamber diaphragm area.
- The air pressure applied to the diaphragm.

The effect of increasing brake application pressure on a brake chamber having a 24 square inch diaphragm as the application pressure is increased from 5 PSI (35 kPa) to 100 PSI, the force generated by the chamber increases from 120 lb (529 N) to 2400 lb (100672 N). Increased brake chamber force causes a harder application of the vehicle's brakes.

Braking force is further multiplied through the slack adjuster. The slack adjuster acts like a lever to multiply brake chamber force to the brake shaft. A brake chamber force of 1000 lb (4459 N) is increased to 6000 lb in. (67885 N cm) through a six inch slack adjuster.

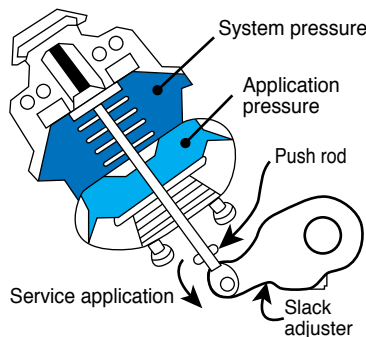

2

Components of the supply circuit of a CMVSS 121 air brake system

The following are the major components of the supply system.

The compressor

The compressor is driven by the engine and provides a flow of compressed air to the reservoirs. The compressor must have sufficient capacity to build air pressure from 345 kPa (50 PSI) to 621 kPa (90 PSI) in three minutes or less with the engine running at 1,200 RPM. This is known as the compressor build-up time and is used to measure the compressor's performance.

The governor

The governor limits the maximum air pressure that can be reached in the system. Maximum air pressure on vehicles manufactured after 1975 is 828 to 897 kPa (120 to 130 PSI). The governor stops the air flow from the compressor when the maximum pressure is reached. Maximum air pressure is often referred to as cut-out pressure, the point when the governor cuts-out the compressor, preventing further air pressure to build-up. As air is drawn from the reservoirs, the air pressure in the system drops. When system pressure drops approximately 173 kPa (25 PSI), the governor causes the compressor to cut-in and supply air to the reservoirs, which increases the system pressure.

The supply reservoir

The supply reservoir is a place for the incoming air to cool. This causes any moisture vapour in the air to condense. The supply reservoir is a gathering place for other contamination, such as oil. All reservoirs should be drained daily to prevent contamination from entering the system and interfering with its operation. The drain cocks should be opened fully to allow all the air to escape.

The safety valve

If the governor fails to cut-out the compressor, the safety valve will prevent excessive air pressure to build-up in the system. This valve is located on the supply reservoir and vents air to the atmosphere if the pressure in the reservoir exceeds 1,035 kPa (150 PSI).

Air dryers

Air dryers remove moisture and contamination from the air before the air enters the reservoirs. The contamination gathered by the dryer is expelled into the atmosphere when the governor cuts out the compressor.

Primary brake circuit

Vehicles that comply with the CMVSS 121 air brake system have two separate service brake circuits, known as primary and secondary. These systems are commonly known as dual braking systems. The primary and secondary service brake circuits are isolated from one another and from the supply circuit by single check valves. These valves prevent air from flowing backward through the system and being lost from a circuit that has failed. Check valves ensure at least one service brake system will remain fully pressurized in the event of an air failure in one of the other circuits. The circuit that remains pressurized will keep the emergency brakes released and allow the driver to bring the vehicle to a controlled stop.

Primary service reservoir

The primary service reservoir stores the air used to control the rear tandem brakes of the vehicle. It receives its air supply from the supply reservoir through a single check valve, which prevents air loss if an air failure occurs in the supply or secondary circuit.

2

Pressure gauge

A pressure gauge mounted on the dashboard shows the available air pressure in the primary reservoir. Some units may be equipped with a gauge that has two needles; one needle indicates primary reservoir pressure and the other shows the secondary reservoir pressure.

Low pressure warning device

A low pressure warning device is used to visually warn the driver when the pressure within the primary reservoir falls below 414 kPa (60 PSI). The most common type of low pressure warning device is a red lamp mounted on the dash accompanied by a warning buzzer.

The dual circuit foot valve (brake pedal)

The dual circuit foot valve allows the driver to apply and release both the primary and secondary service brakes at the same time. The foot valve also controls the force applied by the brakes by regulating the amount of air pressure supplied to the brake chambers. Braking force is determined by the force the driver applies to the brake pedal.

The brakes are released by removing the force from the brake pedal, causing air pressure in the brake chambers to exhaust to the atmosphere.

Secondary brake circuit

The secondary brake circuit is used to apply and release the steering axle service brakes. Units equipped with steering axle brakes that work properly provide the advantage of a shorter stopping distance and greater vehicle stability.

Secondary service reservoir

The secondary service reservoir stores the air used to apply the secondary brakes. A single check valve isolates it from the supply and primary circuits.

Truck-tractor air brake system

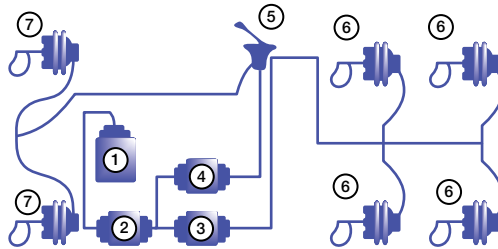

1. Compressor
2. Supply reservoir (wet tank)
3. Primary service reservoir
4. Secondary service reservoir
5. Foot valve (brake pedal)
6. Brakes operated by air supplied from the primary service reservoir
7. Brakes operated by air supplied from the secondary service reservoir

2

Park and emergency brake circuit

The park and emergency brake circuit will hold a fully loaded vehicle on a 20 percent grade without the use of air pressure. It will also apply the brakes on all axles equipped with spring brake chambers if the air pressure in both the primary and secondary service circuits falls below 311 to 138 kPa (45 to 20 PSI).

Parking and emergency brake functions are accomplished through the brakes of the vehicle, which are operated by spring brakes. Spring brakes apply and hold the vehicle's brakes by using spring force rather than air pressure. Air pressure is required to hold the brakes off. This means that air pressure must be available to release the park brakes of a unit before it can be moved. The spring brakes will also be applied if the air pressure falls below 311 to 138 kPa (45 to 20 PSI) due to a complete failure in the system. Control of the spring brakes comes from the park control valve.

The tractor-trailer air circuit

The components of the tractor air circuit are the following.

Supply line

The supply line carries air from the tractor service reservoirs, primary and secondary, to charge the trailer reservoirs.

Service line

The service line carries controlled air pressure from the tractor to apply the trailer's service brakes.

Glad-hand connectors

The glad-hand connectors connect the tractor supply and service lines to the trailer supply and service lines. The supply and service lines must be checked to ensure they are connected correctly.

Trailer supply valve

The trailer supply valve allows the driver to open and close the service and supply lines. This is a pressure sensitive valve that is mounted on the dash. When activated, it triggers the closing of the service and supply lines to the trailer and applies the trailer parking brakes.

Tractor protection valve

The tractor protection valve, with the trailer supply valve, prevents excessive air loss from the tractor's service reservoirs if the trailer air system fails.

Trailer control valve (hand valve)

The trailer control valve is mounted in the cab and applies the trailer's service brakes independently of the tractor service brakes.

The brake chambers

Brake chambers convert the air pressure supplied to them into a mechanical force for applying the vehicle's brakes. The brake chamber consists of two circular metal housings bound by a clamping ring, a rubber diaphragm, a piston, a push rod, and a return spring. Air pressure supplied to the brake chambers from the relay valve acts on the diaphragm to extend the push rod that applies the brakes. When the application pressure is exhausted, the return spring causes the piston and push rod to retract, releasing the brakes.

2

Brake adjustment

A properly adjusted brake is one that provides the shortest brake push rod travel without brake lining to drum contact when the brake is released. Block the vehicle's wheels and release the parking brakes. Shut off the engine and have the transmission in the lowest gear. To determine if a brake requires adjustment, measure how far the brake chamber push rod must travel to fully apply the brake. Maximum push rod stroke varies with the type and size of brake chamber used. The angle formed by the push rod and the slack adjuster must be 90 degrees or more when the brakes are fully applied. The push rod should never go over centre.

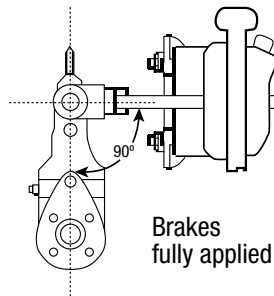

Push rod travel increases due to the wear that occurs between the brake linings and the brake drum. The push rod travel should be checked on every pre-trip inspection. If the push rod travel is excessive, the following procedures may be used to adjust the vehicle's brakes.

One method to adjust the brakes is to lift the wheel off the ground. Block the vehicle's wheels and release the parking brakes. Shut off the engine and have the transmission in the lowest gear. Release the lock on the adjusting capscrew of the slack adjuster and turn the capscrew while rotating the wheel until the brake linings contact the brake drum and the wheel can no longer be rotated. Reverse the rotation of the adjustment capscrew until no drag is felt. The adjustment capscrew locking device must be engaged.

A second method is when the wheel cannot be elevated but a readjustment is necessary. Block the vehicle's wheels and release the parking brakes. Shut off the engine and have the transmission in the lowest gear. Rotate the adjustment capscrew on the slack adjuster until the brake linings contact the drum. Then a visual check is done or the drum is tapped with a hammer. When the linings are not in contact with the drum, the drum will ring. When the linings contact the drum, a dull thud will be heard. The adjustment capscrew is reversed for 1/4 to 1/2 turn. The adjustment capscrew locking device must be engaged. The push rod travel, slack adjuster angle and side to side balance are then rechecked.

Pre-trip air brake inspection

The following information is a guide and does not replace the information in the Alberta Air Brake Course. As in the pre-trip inspection of the vehicle, the driver is a key link in the maintenance chain of an air brake unit. A driver must be alert and know how the air brake system works. Any brake problems must be reported so the necessary repairs can be done.

2

Before doing a pre-trip inspection, check for the following.

- The compressor is secure and there are no visible leaks (if belt driven, check condition and adjustment).
- The lines, fittings, hoses and couplers are in good condition.
- The visible part of the brake drum is not cracked.
- The brake linings are in good condition or are thick enough on assemblies that have no dust plates.

Step one

- Choose terrain that is as level as possible and park the vehicle safely away from traffic.
- Block the wheels to keep the vehicle from moving.
- Set the parking brake. Place the transmission in low gear for a manual, or in park for an automatic.
- Shut off the engine.
- Drain all reservoirs from maximum system pressure to zero.
- Check the low pressure warning devices. They should start working at a minimum of 414 kPa (60 PSI).

Note: Drain the reservoirs every day to prevent moisture or contamination. Clean dry air is a MUST for an air system to operate properly. Too much moisture will cause parts of the brake system to freeze up. Too much oil in the reservoirs may mean the compressor is not working properly. It should be reported.

Note: When draining the air reservoirs, be sure to open the drain cocks fully and drain the system to zero pressure. This is the best way to get rid of contaminants. Always drain the supply reservoir first before draining the service reservoirs.

Step two

- Close the drain cocks and build the air system pressure to its maximum.
- Check that the low-pressure warning devices are working. They should cut out at a minimum 414 kPa (60 PSI).
- Watch how long it takes to build the pressure from 350 to 600 kPa (50 to 90 PSI). It should take three minutes or less with the engine running at 1,200 RPM.
- Note when the governor cuts out the compressor. The governor cut-out should be between 828 to 897 kPa (120 to 130 PSI), depending on the unit.

Step three

- When the engine is idling, fan the brakes until the governor cuts the compressor back in. The difference in pressure from cut-out to cut-in should be between 138 to 173 kPa (20 to 25 PSI).

Step four

Check the reservoir pressure for leaks.

- Have the system at full pressure with the park brake released, then shut the engine off.
- Allow the pressure to stabilize for one minute.
- Watch the dash gauges for two minutes to see how much the pressure drops. In a single vehicle, the pressure should not drop more than 13.8 kPa (2 PSI) in either reservoir. In a tractor-trailer unit, the pressure drop should not be more than 27.6 kPa (4 PSI) in either reservoir.

2

Step five

- Build the system air pressure to its maximum.
- Fully apply and hold the brakes.
- After letting the system pressure stabilize for one minute, check the dash gauges for a pressure drop. In a single vehicle, the pressure should not drop in either service reservoir by more than 27.6 kPa (4 PSI) in two minutes. In a tractor-trailer unit, the pressure should not drop by more than 41 kPa (6 PSI).

Step six

- Apply the brakes and hold at 690 kPa (100 PSI).
- Check the brake chamber push rod travel and slack adjuster angle. If the push rod travel is excessive, the brakes will need to be adjusted.

Step seven

Check the manual emergency system.

For a single unit truck or a bus do the following.

- Manually operate the park control valve with the engine idling. The park brakes should apply and release promptly.

For a tractor-trailer unit do the following.

- Manually operate the trailer supply valve with the engine idling. The trailer park brakes should apply and release promptly.
- Manually operate the park control valve. All parking brakes on the unit should apply.

Step eight

Check the automatic emergency system.

For a single unit truck or a bus do the following.

- Build air system pressure to its maximum.
- Shut off the engine.
- Fan the brakes until the pressure drops low enough to activate the park control valve.

All the spring brakes on the unit should respond.

For a tractor-trailer unit do the following.

- Build the system pressure to its maximum.
- Disconnect the trailer supply line. The trailer brakes should apply immediately. Tractor air pressure should go down until the tractor supply valve closes the supply line.

Step nine

Perform a brake response test.

- Move the vehicle forward one metre and apply the trailer hand valve.
- Repeat the test using the vehicle's foot valve. It is possible to tell from this test whether all of the vehicle's brakes are operating properly.

2

Air brake equipped farm vehicles

In Alberta, you are not required to hold an air brake endorsement if operating a single motor vehicle registered as a farm vehicle. However, you do need an air brake endorsement if driving a farm vehicle combination that requires the driver to hold a Class 1 operator's licence. When applying for a Class 1 operator's licence, you will need to show proof of your air brake qualifications, even if the vehicle you will be driving is registered as a farm vehicle.

Starting out

It is important to know the transmission shift pattern of the truck you are operating. If you are not sure, refer to the vehicle owner's manual.

Rest and check stop inspections

Rest and check stops serve two purposes. First, they provide a break and a change of routine. You will feel less tired and more alert after a rest stop. Second, you can check your vehicle after it has been on the road for some time. You will be able to see if everything is still secure and working the way it should.

Schedule rest and check stops according to National Safety Code (NSC) requirements and your company's policy.

When choosing a stop, keep the following in mind.

- Make sure the vehicle is completely off the road.
- You should be able to enter and exit a rest or check stop so that you do not have to back the vehicle.
- Do not make a stop at the bottom of a hill or on an uphill slope if you need to accelerate quickly when leaving the stop area.
- The stop area should have an adequate acceleration lane to allow you to merge on to the highway at the appropriate speed.

A vehicle inspection at a rest and check stop should include the following.

- All lights are clean and in working order.
- There are no air leaks.
- All the wheels are secure, and tires are properly inflated and are not hot.
- There are no broken or loose items on the vehicle.
- The load is secure.
- The dangerous goods placards are clean and secure (if applicable).
- The trailer locking mechanisms are secure and in good condition.
- The brakes are properly adjusted.

2

End of trip inspection and report

At the end of a shift, you must do an end of the trip inspection and report. This will enable you to obtain service or repairs if required before the next trip. The report should include any problems discovered during the trip. Waiting to do the inspection can result in problems that are frustrating, time consuming and costly.

Coupling and uncoupling a semi-trailer

Coupling with a fifth wheel

The basic steps in coupling a semi-trailer are as follows.

- Block the trailer wheel. If you only have one block, place it to the rear of the trailer wheel. If you have two blocks, place them to the front and rear of the trailer wheel.
- Check whether the jaws on the fifth wheel are in the unlocked position.
- Check the condition of the trailer apron, pin and collar.
- Back the tractor in line for the hook-up with the trailer. Stop before contact is made between the fifth wheel and the trailer apron.
- Check that the height of the fifth wheel and the trailer match.
- Connect the air lines from the tractor to the trailer.
- Fill the trailer air tanks and set the trailer brakes. (Note: Some trailers may not have spring brakes.)
- Back the tractor until you feel and hear the connection.
- Perform tug test to make sure you have a good hook-up. If a noticeable slack is seen, make the correction.
- Check to see whether the fifth wheel jaws are properly locked around the trailer pin.
- Raise the landing gear and hook-up the electrical line to the trailer.
- Remove the wheel blocks.

The basic steps in uncoupling a semi-trailer are as follows.

- Park the tractor and trailer in a straight line.
- Secure the tractor with the parking brake or maxi.
- Set the trailer brakes. If you have only one block, place it to the front of the trailer wheel. If you have two blocks, place them to the front and rear of the trailer wheel.
- Lower the landing gear.
- Disconnect the electrical connection and air lines, and then unlock the fifth wheel.
- Secure the electrical connection and air lines to the tractor.
- Move the tractor ahead slowly until the fifth wheel almost clears the trailer.
- Stop and check that the ground and landing gear support the trailer.
- Move the tractor ahead slowly until the fifth wheel completely clears the trailer.

Coupling and uncoupling pintle hitch attachments

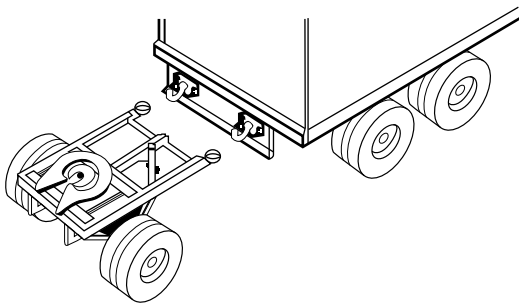

Pintle hitch with hook and eye

2

The basic steps in coupling pintle hitch attachments are as follows.

- Position the towing/power unit in line to receive the pintle eye.
- Stop the towing/power unit before contact is made with the pintle eye.
- Block the trailer wheels.
- Ensure the pintle hook is open to receive the pintle eye.
- Ensure pintle hook and eye have no cracks or excessive wear.
- Ensure the pintle eye is the proper height to lower onto the pintle hook. Adjust the drawbar height if necessary.
- Position the towing/power unit so the pintle eye can be lowered onto the pintle hook.
- Snap the pintle hook shut and ensure the safety latch is locked.
- Properly attach the safety cables and/or chains to the towing/power unit.
- Fasten the safety pin (if applicable).
- Properly attach the air lines, electrical line and other associated hoses (if applicable).
- Charge the air system. If equipped with a “no-slack ram,” do a tug test to ensure that the ram is energized.
- Perform a visual inspection to ensure all locking mechanisms are secured.
- Place the landing leg (if applicable) in the transport position and remove the blocks.
- Ensure the hitching devices are secure and re-check the safety latch.

The most important task in the coupling procedure is to physically and visually check all the connections. Failing to do so may cause a serious incident.

The basic steps in uncoupling pintle hitch attachments are as follows.

- Park the towing/power unit and trailer in a straight line.
- Set the parking brakes of the towing/power unit and trailer.
- Block the trailer wheels.
- Disconnect the air lines, electrical line and other associated hoses (if applicable).
- Disconnect the safety cables/chains from towing/power unit.
- Disconnect the safety pin (if equipped).
- Release the pintle hook locking (safety latch) mechanism.
- Lower the landing leg if equipped; otherwise, block the drawbar when required.
- Move the towing/power unit ahead slowly until the pintle eye completely clears the pintle hook.
- Stop and visually check that the pintle eye is free of the pintle hook.

Coupling mechanisms

Double trailer combination types

When adding a second trailer to the rear of a lead trailer, a converter mechanism is needed. Each converter must have its own fifth wheel attachment. There are three different kinds of converters.

A train

This converter has an A shaped drawbar that joins into a single pintle hitch point on the lead trailer. Due to its A shape, it is often called an A-dolly.

2

When two trailers are joined together using the A-dolly, the whole unit is called an A train. These converters provide two points of articulation (joints that allow side to side or lateral movement). One of these points is at the pintle and the other is at the fifth wheel.

A train – example of a unit connected by a type A converter dolly.

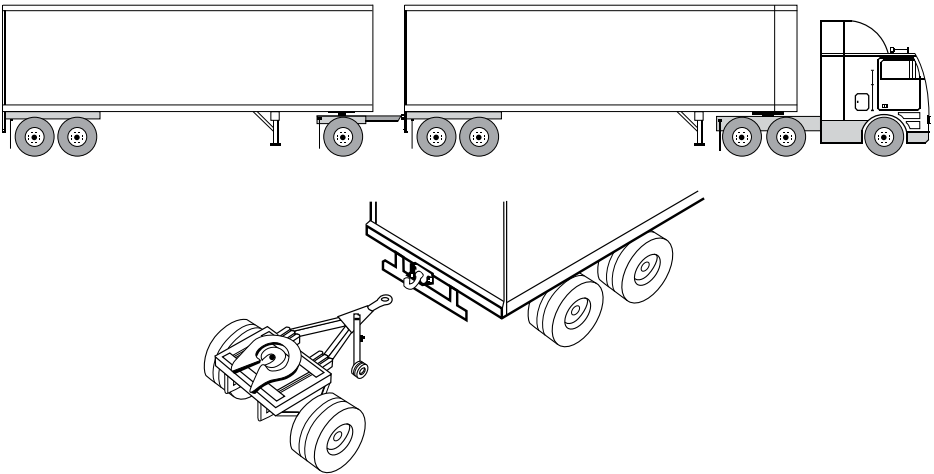

B train

In a B train, the converter is part of the lead trailer. The fifth wheel assembly sits on the rear axle of the lead trailer. It is either permanently fixed in position or slides out with the rear axle.

No converter dolly is required, as the second unit connects directly to the extended frame of the lead unit.

B train – example of a unit connected by a type B converter dolly.

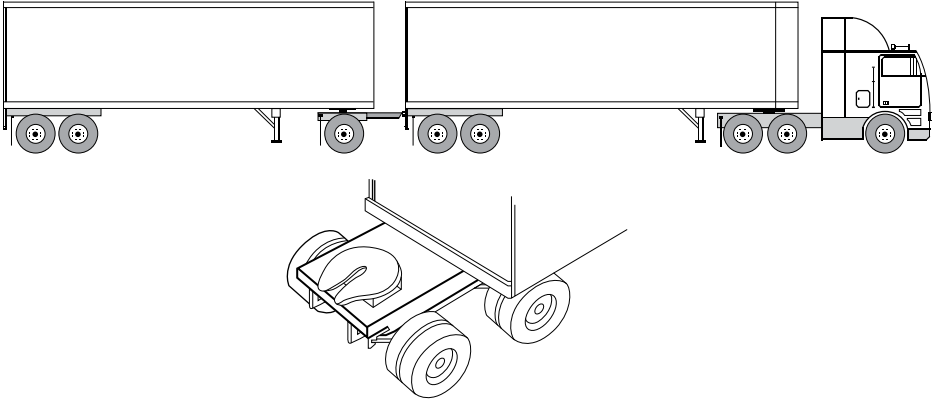

C train

A C train is like the A train, in that it uses an independent converter. The difference between the two is that the C train has two drawbars and two pintle hitches in the double drawbar converter.

Two bars mean there is only one articulation point. The result is that the trailer moves less from side-to-side. To improve performance even more, double drawbar converters have a built-in steering ability (self-steering axle).

When driving a C train, check that the air pressure on the self-steering axle is within the manufacturer's standards. If the air pressure falls too low, the wheels will steer too much and the unit becomes unstable. This can lead to skid steering, which can damage the converter and hitch.

2

C train – example of a unit connected by a type C converter dolly.

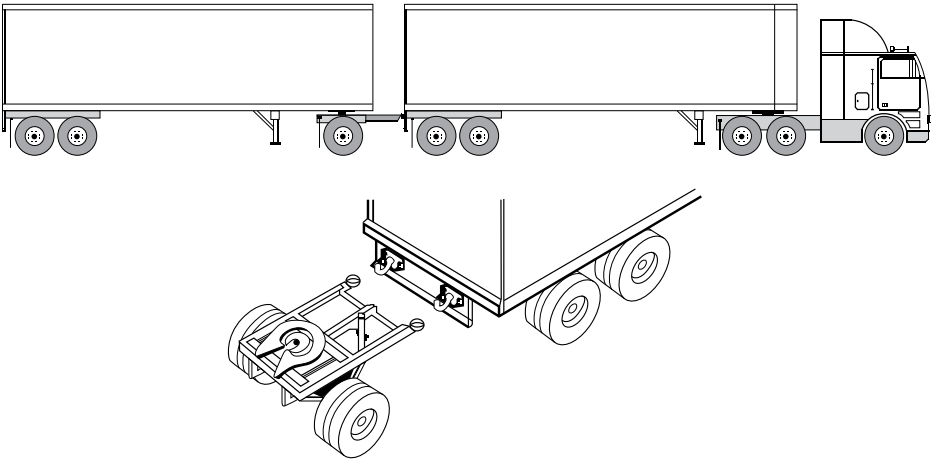

Link-up arrangement

When linking two or more trailers to a towing unit, always hook the heaviest trailer directly to the tractor. The lightest trailer should be the furthest away from the towing unit. This rule applies no matter how long each trailer is. If the trailers are not joined according to weight, the unit will be unstable. The rear trailer will sway and control of the unit could be lost.

Examples of extended length vehicles

Rocky Mountain Double

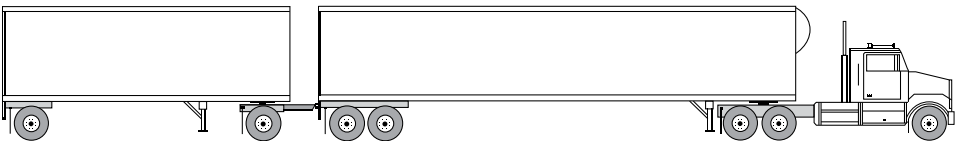

Triple

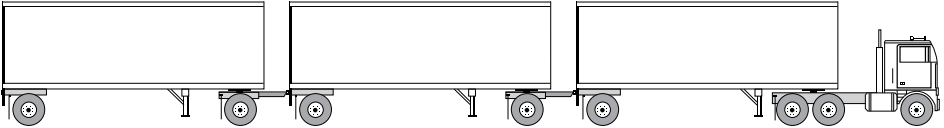

Turnpike Double

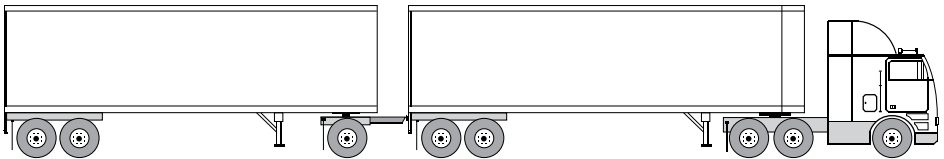

Operating long combination vehicles

When a permit is issued according to Section 62 of the *Traffic Safety Act* authorizing the movement of Long Combination Vehicles (LCVs), a list of general provisions must be followed. Some of these provisions are listed below.

Note: For a complete, current list of all provisions, carriers who wish to operate LCVs should contact:

Alberta Transportation
Transport Engineering Branch
Calgary 403-340-5189

For toll-free service from anywhere in Alberta, dial 310-0000.

2

- Companies must have and be able to provide proof that their drivers and driver trainers meet and maintain the requirements outlined in the Canadian Trucking Alliance's *Longer Combination Vehicle Driver's and/or Instructor's Manual*.
- The carrier is responsible for issuing an annual LCV Driver's Certificate. The Driver's Certificate is valid for 12 months after the date of issue, and must be in the possession of the driver at all times when operating an LCV. Before issuing an LCV Driver's Certificate, the carrier must ensure that the driver meets the following qualifications. The driver:
 - * holds a valid Class 1 driver's licence or equivalent
 - * has passed a recognized air brake course
 - * has a minimum of 24 months or 150,000 kilometres of driving experience with articulated vehicles in the Class 1 category
 - * has passed a Professional Driver Improvement Course (PDIC) within the past 48 months
 - * has passed the Canadian Trucking Alliance's *Longer Combination Vehicles Driver Training Course* or equivalent
 - * has a driver's abstract that is dated not more than one month prior to the issue date of the Driver's Certificate. It must show no driving-related criminal code convictions in the prior 36 months; no more than two moving violations in the prior 12 months; and no more than three moving violations in the prior 36 months. The date of conviction and the current date are the dates used to determine the time periods.
 - * has in the past 12 months been instructed on all current regulations, permit conditions and issues covering the operation of LCVs.

Load security

It is extremely important to ensure that all cargo carried by a commercial vehicle is properly secured according to the requirements of the *Canadian National Safety Code (NSC) Standard 10*, adopted by Alberta under the *Traffic Safety Act*. The new rule came into effect on February 1, 2005 and requires the trucking industry to abide by specific standards when securing commercial loads.

- *A carrier shall not permit a driver to operate a commercial vehicle where the cargo transported in or on the vehicle is not contained, immobilized, or secured in accordance with the NSC Standard as it relates to the particular type of commercial vehicle.*
- *A driver shall not operate a commercial vehicle where the cargo transported in or on the vehicle is not contained, immobilized, or secured in accordance with the NSC Standard as it relates to the particular type of commercial vehicle.*
- *A driver or carrier must ensure that cargo transported by a commercial vehicle is contained, immobilized or secured so that it cannot:*
 - * *leak, spill, blow off, fall from, fall through or otherwise be dislodged from the vehicle*
 - * *shift upon or within the vehicle to such an extent that the vehicle's stability or ability to move is adversely affected.*

If cargo is not properly secured, the driver, carrier, or shipper could face fines and penalties.

The North American Cargo Securement Standard Model Regulation can be viewed on the Canadian Council of Motor Transport Administrators website at: www.ccmta.ca

2

Speed limits for long combination vehicles

The maximum speed limit for drivers of long combination vehicles shall not be more than 100 km/h or the posted speed limit, whichever is lower.

Braking distance

The function of any braking system is to slow the motion of a moving vehicle. Heavy commercial vehicles take more time and more distance to stop than smaller vehicles. This is because they need more braking force to overcome their weight and forward motion.

The distance a commercial vehicle needs to stop is affected by the following four factors.

1. **Brake condition.** All the brakes on a vehicle must share the task in the same way. If one or more brakes are not properly aligned or maintained, the remaining brakes will have to generate more friction. This means that it will take longer to stop the vehicle.
2. **Traction.** Traction is the friction between the road surface and the area where the tire contacts that surface. The amount of traction a vehicle has depends on:
 - the condition of the road
 - how much tire contact there is with the road surface
 - the condition and inflation pressure of the tires
 - the gross vehicle weight (GVW) of the vehicle.

The more traction the vehicle has, the less time and distance it will take to stop. There is the most traction just before all the wheels lock up. There is less traction when the wheels are skidding.

3. **Weight (GVW).** A heavy vehicle, even though it has better traction, needs more time and distance to stop. When the weight is doubled, the amount of force needed to stop the vehicle is doubled, and it will take about twice as long for that vehicle to stop (Figure 1).
4. **Speed.** The greater the speed, the more time and distance are needed to stop. Figure 2 illustrates that doubling the vehicle speed means that four times the braking force is required to bring the vehicle to a stop. Figure 3 illustrates that if both the speed and weight are doubled, the amount of force required to stop the vehicle will be increased by eight times.

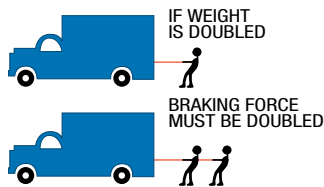

Figure 1

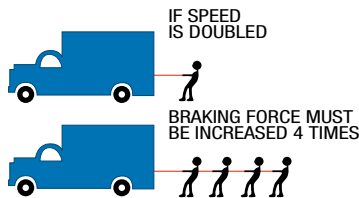

Figure 2

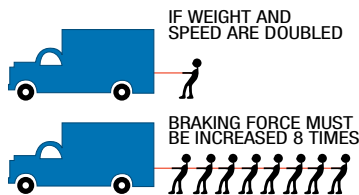

Figure 3

2

Stopping distance

The total stopping distance to bring a vehicle to a complete stop is measured from the time a driver realizes the need to apply the brakes until the vehicle comes to a full stop. The time it takes for a vehicle to stop is affected by four factors.

1. **Perception time** is the amount of time it takes a person to realize the need to stop the vehicle. The average perception time is about three-quarters of a second. Perception time can increase if a person is not paying attention to driving, or is not feeling well physically or mentally.

Perception distance is how far a vehicle travels during this time.

2. **Driver reaction time** is the amount of time it takes between deciding to stop and actually applying pressure to the brake pedal. Normal driver reaction time is about three-quarters of a second. Reaction time will be slower if the driver:
 - is tired, or
 - has been drinking alcohol or using drugs.

Reaction distance is how far a vehicle travels during this time.

3. **Lag time** is the amount of time it takes for the air brake system to respond after the driver has applied pressure on the brake pedal. Air brakes do not respond immediately because it takes time for the compressed air to flow through the system and apply the brakes.

Lag time distance is how far a vehicle travels during this time.

4. **Braking time** is the amount of time it takes for the vehicle to come to a complete stop after the brakes have been applied. Braking time depends on:

- the force with which the brakes are applied
- the condition of the brake linings and drums
- the traction of the tires on the road surface
- the vehicle weight and speed.

Braking distance is how far a vehicle travels during this time.

Total stopping distance is the sum of perception distance, reaction distance, lag time distance and braking distance.

General braking information

- When applying the brakes, press down the pedal using an even pressure and then ease off the pedal as the vehicle slows down. Just before the stop, release the brakes to avoid a sudden jerk or rebound. Then apply pressure to the brake pedal again to hold the vehicle while it is stopped.
- Do not fan (alternately applying and then releasing) the air brakes as this wastes air pressure. Fanning the brakes on a long downhill grade may mean that you do not have enough air pressure for the brakes to work properly.
- Avoid using the brakes too much going down hills. Downshift before going over the top of the hill. Use engine compression as a way to control your speed on steep grades.
- If there is a low air pressure warning, stop as soon as possible in a safe place. Increase the air pressure before continuing.
- Before going down a hill, test the brakes. Look at the air pressure gauge, apply the brakes, and check for abnormal air pressure loss. Do not proceed if there is abnormal pressure loss.

2

- If the trailer hand valve is used too much, particularly on steep hills, the trailer brakes may fail. Use of the trailer hand valve only is not recommended as it leads to a greater wear on the trailer brakes than the truck-tractor brakes. This causes unbalanced braking between the truck-tractor and the trailer, which could cause the unit to jackknife.
- Always be sure the brakes are adjusted properly. If they are not, some brakes will have to work harder than the others. This could cause a skid.
- A driver must not pull any trailer that weighs more than 2,300 kg that is not equipped with brakes controlled by the driver.

Following distance between vehicles

Remember that the two-second rule is the minimum following distance for passenger vehicles and is accurate at any speed. When operating a large vehicle, use the **four-second** rule to determine a safe following distance. Watch the vehicle ahead pass a fixed object, like a telephone post, and start to count one-thousand-and-one, one-thousand-and-two, and so on. If you reach the object before counting to one-thousand-and-four, you are following too closely. You must slow down to increase the distance between your vehicle and the vehicle ahead.

Double and triple trailer units take up more space than other commercial vehicles. They are not only longer, but also need more space because they can not turn or stop as quickly. Allow more following distance. Make sure the gaps are large enough before entering or crossing traffic. Be certain you are clear at the sides before changing lanes. When weather, road or traffic conditions are poor, **double your following distance**.

Off-tracking

In any vehicle where the rear axle cannot steer during a turn, the rear tires will follow a different path than the steering tires. This is called off-tracking. There are two types of off-tracking.

1. Low speed off-tracking is common when driving in a city. In low or moderate speed turns, the rear tires are pulled inward of the steering path. The longer the wheelbase of the vehicle or the tighter the turn, the more off-tracking occurs.
2. High speed off-tracking is the effect of centrifugal (outward) force. It is seen when a vehicle travels at higher speeds, and the rear tires pull outward from the steering path during a turn. When you are driving a large vehicle, use a moderate speed when entering curves on open highways. Otherwise, you may encounter serious high-speed off-tracking that may result in a dangerous situation.

Turns

It takes different skill and knowledge to turn a large vehicle compared to turning a passenger vehicle. To start, have a look at the general turn rules that are explained in the *Basic Licence Driver's Handbook*. Remember the off-tracking tendencies of the large vehicle, and that it has a wider turning radius. The hand-over-hand steering method is recommended. Always use both hands to steer the vehicle. Select the appropriate gear before starting the turn unless the vehicle has an automatic transmission.

2

Right turns

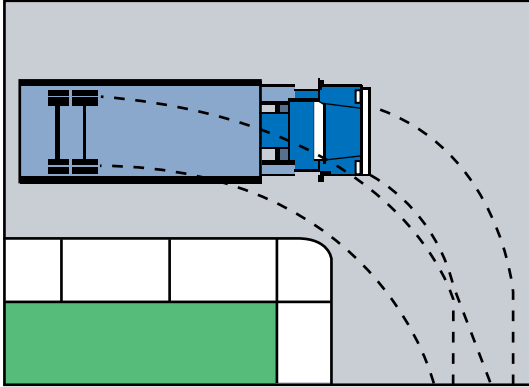

Be aware that, for every turn of the steering wheel, the rear wheels will follow a shorter path than the front wheels. Allow for this low speed off-tracking on every turn. Otherwise, your vehicle could hit another vehicle, or stationary object, or run over a curb and hit a pedestrian.

If the street is narrow, drive well into the intersection before starting the turn. You might need to go over the centre line of the street you are entering or into the second traffic lane. Whenever making a turn, be cautious and ensure it can be done safely.

Look for smaller vehicles and cyclists that may try to pull along the right side of your tractor-trailer during the turn.

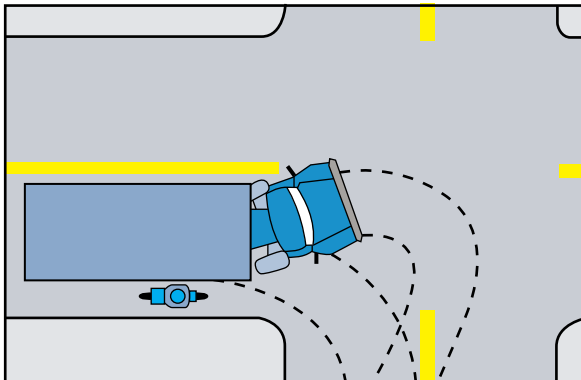

Left turns

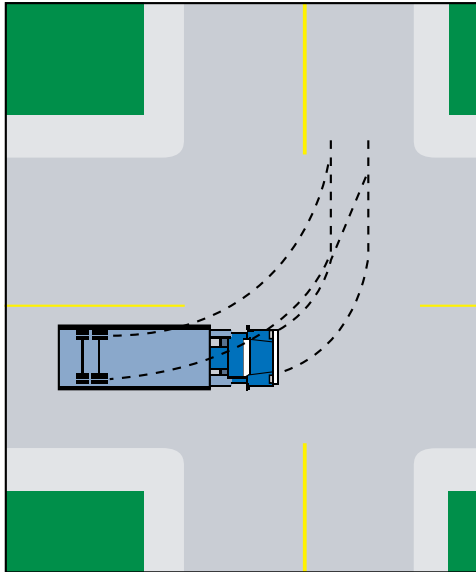

When turning left, ensure your vehicle's turning arc is wide enough to allow the vehicle to off-track on the left side without crossing the centre line. Your turn must be wide enough to prevent the vehicle from cutting the corner and hitting another vehicle. Complete the turn by driving to the right side of the centre line of the road entered.

2

Curves

Enter a curve at a speed that does not require braking, but does allow you to gradually accelerate while in the curve.

When entering a curve, centrifugal force acts on the vehicle. This force pushes the vehicle towards the outside of the curve.

Traction resists centrifugal force. The amount of traction your wheels have with the road's surface determines the amount of control that can be maintained over the vehicle.

When speed is increased, both momentum and centrifugal force are greater. When entering a curve too quickly, these forces may be greater than the traction that is present. This can cause a loss of control of the vehicle. If you are travelling at too great a speed and try to slow down by applying the brakes, this may cause the vehicle to skid, roll over or jackknife.

Right curves

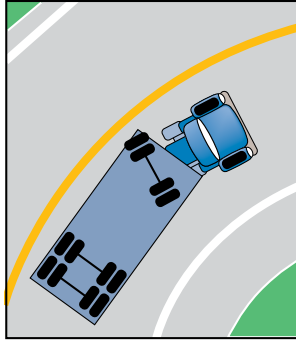

Keep the front of the vehicle closer to the centre of the road so the trailer wheels do not roll over the curb or drop off the pavement on the right.

Left curves

Keep the front of the vehicle closer to the outside of the curve (right side

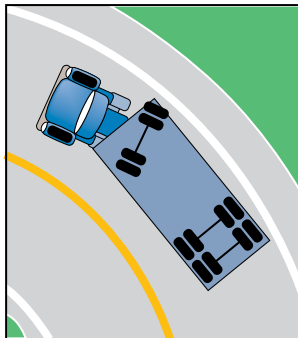

of road) so the trailer wheels do not cut into the other lane of traffic on the left.

2

Parking



Always select a safe place to park the vehicle. Set the parking brake in the tractor. Do not use the trailer hand valve to hold a parked unit. Put the transmission in the lowest forward or reverse gear (if applicable). If the vehicle has a two-speed axle, put the axle in low range.

Properly block the wheels using wheel chocks or square blocks. The minimum size for the square blocks should be 15 centimetres by 15 centimetres.

Do not expect the transmission to do the work of securing the vehicle. Always use the vehicle's parking brake system and wheel blocks.

Parking on a hill

The law requires that the wheels of a parked vehicle be no more than 50 centimetres from the curb. When parked, the vehicle must be left in low gear or reverse for a manual transmission or park for an automatic transmission. Have the park brake engaged. The following information applies to vehicles parked on the right-hand side of the road. For vehicles parked on the left-hand side of the road (one-way), turn the front wheels in the opposite direction.

- For parking downhill, with or without a curb, the front wheels should always be turned to the right.
- For parking uphill with a curb, the front wheels should always be turned to the left.
- For parking uphill without a curb, tractor-trailer units with one articulation point should always have the front wheels turned to the left.

Note: If there is a curb, allow the vehicle to roll to the point where the front tire closest to the curb is making contact with the curb before setting the parking brake. This helps to prevent the vehicle from jumping the curb if the vehicle starts to move.

Backing (reversing)

- When backing a tractor-trailer, turn the steering wheel in the opposite direction to where you want the trailer to go. Another method is to place your hand on the bottom of the steering wheel and move your hand in the same direction that you want the trailer to go. The truck-tractor must follow an S-shape in order to bring the trailer around smoothly.
- Always back the vehicle slowly and use both the rear view mirrors. Never forget that there is always a blind spot directly behind the vehicle that is not visible in the mirrors.
- Avoid unnecessary backing by planning ahead.
- Sound the horn as a safety precaution before backing. Repeat at least once for every vehicle length backed.
- If possible, ask someone to act as a guide. The guide must be able to see the path the vehicle is taking. The driver must be able to see the guide. Stop if you cannot see the guide.
- Remember that even with a guide, the driver is still responsible for all movements of the vehicle.
- If it is not possible to have a guide, always check the area where you are backing before beginning the move. Get out of the vehicle, walk behind it and visually check the area. Look for obstructions and clearance.
- If the backing distance exceeds two vehicle lengths, stop, get out and visually recheck the areas behind, above, below and around the entire unit.
- Keep your foot off the throttle. You will rarely need to use it to start your unit backing. Always select the lowest reverse gear available. Move very slowly and keep your right foot covering the brake pedal in case you need to stop quickly.

2

Straight line backing

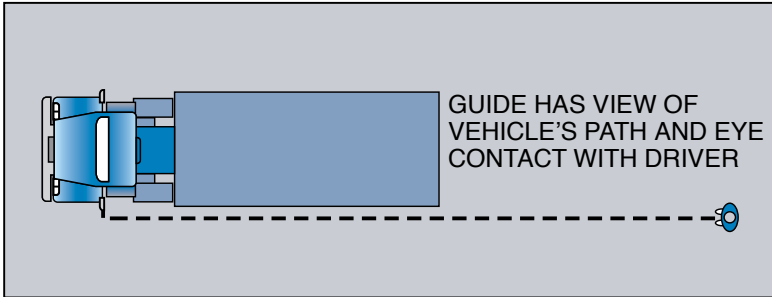

Straight line is the easiest and safest form of backing. Back straight whenever possible. Normally you will have a clear view in both mirrors of the space that you are backing into.

90 degree backing, clear side (left side)

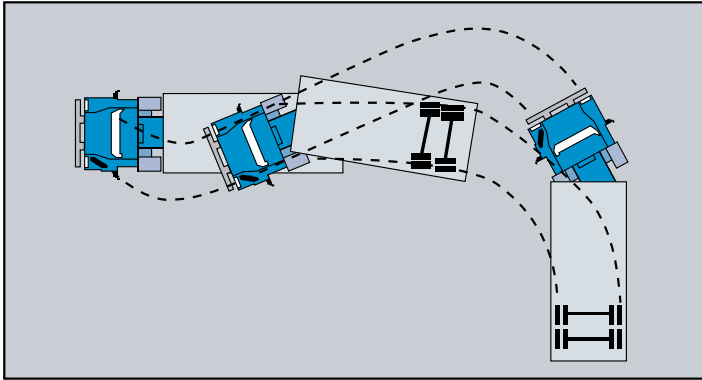

Backing to the left provides a clear view in the left mirror of the space you are backing into.

Start backing and turn the steering wheel to the right to move the trailer to the left. Once the trailer is curving towards the space, turn the steering wheel to the left and let the truck-tractor follow the trailer into the space.

When the trailer is in line with the parking space, turn the steering wheel even more to the left to straighten the tractor in relation to the trailer. Slowly finish backing into the loading truck-dock or parking space.

2

90 degree backing, blind side (right side)

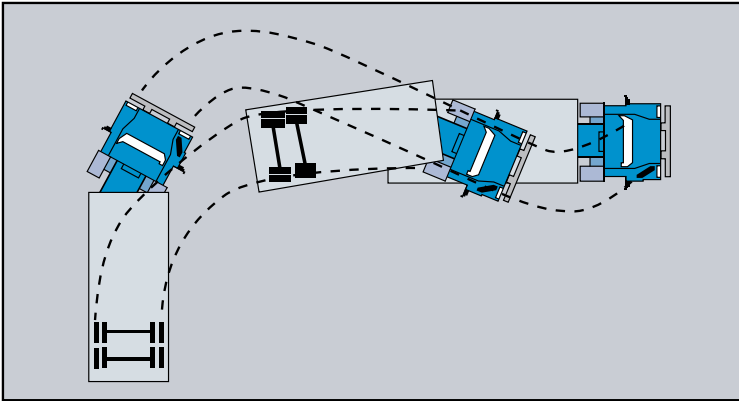

Backing from the blind side uses the same steps as clear side backing. However, it is harder to see where you are going. Once the backing has started, you will mostly be using the right side mirror, including the convex mirror.

You should stop often and get out of the truck-tractor to check your position.

This type of backing is the most difficult and also potentially the most dangerous. Avoid it if you can.

Other important information for truck drivers

- When carrying logs on a vehicle, the overhanging logs may swing across the other traffic lanes when you turn. Try to let traffic behind pass before you make the turn.
- If a breakdown occurs on the highway, park the vehicle as soon as possible, in a safe position on the right side of the roadway.

- If the breakdown occurs on a highway, outside the limits of an urban municipality between sunrise and sunset (during the day), activate the emergency hazard lights. Place approved warning devices (lights or flares) on the highway in line with the vehicle about 30 metres (about 100 feet) in both front and back of the vehicle.
- If the breakdown occurs on a highway, outside the limits of an urban municipality between sunset and sunrise (in darkness), or anytime when there is not enough light to clearly see people or vehicles on a highway at a distance of 150 metres, activate the emergency hazard lights. Place approved warning devices (lights or flares) 75 metres (about 250 feet) in front of and behind the vehicle.
- If your truck is carrying explosives or flammable goods, you must stop before every uncontrolled railway crossing.
- When driving in urban areas (cities and towns), you must drive only on the routes specified for trucks and dangerous goods vehicles.
- If driving a vehicle that carries dangerous goods, you must comply with the federal and provincial laws describing how dangerous goods should be handled, stored and transported. These laws were created for the safety of the public.

Note: If your truck or vehicle is carrying goods or commodities to the United States, and this is not something you do on a regular scheduled basis, you must contact either the Department of Transportation or the Department of Highways **in each state** where you will be travelling before starting your trip. Each state has different laws. Your trip will be faster and smoother if you obtain all the proper permits and documents before you go.

2

National Safety Code

On April 1, 1989 each province and territory in Canada agreed to a set of performance and safety standards for motor carriers, and the National Safety Code (NSC) came into effect. Alberta, like the other jurisdictions, has passed legislation to put these standards into effect.

In Alberta this legislation applies to:

- trucks and vehicle combinations having a registered gross vehicle weight (GVW) of 11,794 kg or more
- commercial vehicles (buses) having a manufactured seating capacity of 11 persons or more, including the driver.

Note: In jurisdictions outside Alberta, the legislation relating to the National Safety Code may have different requirements. The carrier and driver are responsible for knowing the requirements of each jurisdiction in which that driver operates.

All carriers who own one or more of these vehicles must hold a National Safety Code rating. They must have a Safety Fitness Certificate from the jurisdiction in which their vehicles are registered.

In Alberta, farmers are exempt from most of the legislation when hauling their own products. However, they must comply with legislation related to the mechanical fitness of vehicles.

Although much of this legislation addresses the carrier's responsibilities, the driver plays an important role in all of the areas.

Safety plans

In Alberta, every regulated carrier must have and implement a written safety plan outlining company policies and procedures about specific administrative and operational subjects. These include:

- vehicle operation, including speed limits, drug and alcohol use, proactive driving
- following the law
- driver qualifications
- training and evaluation of the company's drivers
- document completion
- driver discipline
- the contents of each driver's file
- written instructions for using safety equipment, such as highway warning devices.

All drivers have a responsibility to know and follow the policies and procedures contained in their company's safety plan.

Each driver should:

- have received the training specified in the company's safety plan and know how to perform the duties properly and safely
- ensure that the vehicle is being operated in compliance with the owner's policies and procedures, and within the law
- have all the required documentation completed and in his or her possession when required, such as Bills of Lading and Dangerous Goods documents
- be medically fit to drive and not fatigued or under the influence of alcohol or any drug

2

- be qualified to operate the vehicle and have any required documents, such as a valid operator's licence, vehicle registration and Dangerous Goods Training Certificate
- report any violations, convictions, and collisions to the carrier.

For more information, refer to the *Commercial Vehicle Certificate and Insurance Regulation AR 314/2002*, which is available from the Queen's Printer. (See *Need more information* at the end of this section.)

Preventive maintenance plans

In Alberta, regulated carriers are required to have and follow a written preventive maintenance plan. The plan must provide for a regular and continuous program of maintenance, inspection and repair of the carrier's vehicles, as specified by the regulations.

Every driver is responsible to:

- carry out those inspections required by the owner
- carry out any inspections required by legislation, such as vehicle trip inspections
- complete any documents required by the owner, and return those documents to the owner
- ensure the vehicle is inspected, or make it available for inspection, as specified in the company's preventive maintenance plan
- report any on-road inspections received and provide the documents to the carrier
- notify the carrier of any mechanical defects found during an inspection
- not operate any vehicle with a defect that would jeopardize the safety of the driver or any other person.

For more information, refer to the *Commercial Vehicle Maintenance Standards Regulation AR 118/89*, which is available through the Queen's Printer. (See *Need more information* at the end of this section.)

Hours of service

Hours of service legislation is safety legislation that ensures commercial drivers have enough opportunities to rest so they do not drive when tired.

There is both federal and provincial legislation that determines the *on duty* and *off duty* hours of a driver. The Alberta legislation applies to a driver who is operating "point to point" within Alberta. The federal legislation applies at all other times.

The two sets of regulations are similar. However, the federal legislation contains cumulative rules that the Alberta legislation does not. These rules are explained below.

Provincial (Alberta) legislation

The on duty hours allowed for a driver are regulated in work shifts that generally start after having a period of eight consecutive hours off duty and end when the driver has another period of eight consecutive hours off duty. Some situations are considered equivalent to this eight hour off duty requirement.

During a work shift, a driver can not drive:

- after having driven 13 hours, or
- after being on duty for 15 hours.

2

A driver must account for every day by completing a daily log for each day worked, or indicating in the remarks section of the daily log that the driver was off duty on the indicated dates.

If ALL of the following four conditions are met, a daily log is not required to be completed. However, all other regulated requirements must still be met.

- The driver starts and ends the work shift at the same place.
- The driver stays within a 160 kilometre radius of the home terminal.
- There must be no more than 15 hours from the time the driver starts work until relieved of duty.
- The employer must maintain a record for at least six months of the time each driver starts and ends a shift.

When required to complete a daily log, a driver must do the following.

- Enter all the required information.
- Maintain the daily log current to the last change of duty status, such as off duty time and driving time.
- Maintain the daily log accurately.
- Keep copies of documents received during the trip, such as hotel receipts and fuel receipts.
- Deliver the daily log, and all supporting documents, to the employer within 20 days.
- Keep a copy of each daily log and supporting documents for at least six months.

The driver's employer must maintain the daily logs, in an orderly manner, for six months.

For more information, refer to the *Drivers Hours of Service Regulation AR 317/2002*, which is available through the Queen's Printer. (See *Need more information* at the end of this section.)

Federal legislation

The conditions summarized above are also required by federal legislation.

As stated earlier, the major difference between federal and Alberta hours of service legislation is the cumulative rules. These rules place additional limitations on the driver to help prevent driver fatigue.

These cumulative rules state that a driver cannot drive after:

- 60 hours on duty in seven days,
- 70 hours on duty in eight days, or
- 120 hours on duty in 14 days.

For more information refer to the *Commercial Vehicle Drivers Hours of Service Regulation SOR/94-716*, which is available through Government of Canada Publications. (See *Need more information* at the end of this section.)

Need more information?

To learn more about this legislation or to ask questions about the requirements, check the following.

Alberta legislation is available from the Queen's Printer at: www.qp.gov.ab.ca or phone 780-427-4952 or 403-297-6251. For toll-free service from anywhere in Alberta, dial 310-0000.

2

Federal legislation is available at Government of Canada Publications at: <http://publications.gc.ca> or phone 1-800-635-7943.

More information is available from Alberta Transportation at: www.infra.gov.ab.ca

Write or visit:

Alberta Transportation
Vehicle Safety and Carrier Services
Room 401, Provincial Building
4920 – 51 Street
Red Deer, Alberta
T4N 6K8
403-340-5021

For toll-free service from anywhere in Alberta, dial 310-0000.

Commercial Vehicle Inspection Program (CVIP)

To maintain and enhance the safety of commercial vehicles travelling on Alberta highways, the province has developed a mandatory safety inspection program. This is called the Alberta Commercial Vehicle Inspection Program (CVIP).

CVIP is not a replacement for the ongoing preventive maintenance carried out by vehicle owners, but rather sets the standards for owners' maintenance programs.

A commercial vehicle passing inspection under CVIP will receive a Commercial Vehicle Inspection Certificate, as well as a decal to be placed on the vehicle.

As with the National Safety Code, municipal transit buses and farm trucks are exempt from the inspection program.

Which commercial vehicles need to be inspected under CVIP?

Buses

All buses designed to carry more than 11 passengers, including the driver, must be inspected. This does not include municipal transit buses, but does include both school buses and commercial buses. Buses must be inspected every six months. Since 1978, Alberta has had a semi-annual inspection requirement for buses.

Trucks and trailers

All trucks, truck-tractors, trailers and semi-trailers with a registered combined gross vehicle weight (GVW) of 11,794 kg or more must be inspected. Trucks and trailers must be inspected every 12 months. These are the same vehicles that are governed under the National Safety Code.

2

How can I find out more about the Commercial Vehicle Inspection Program in Alberta?

For more information about inspection of commercial vehicles in Alberta, or to apply for a Commercial Vehicle Inspection Station Licence or a Commercial Vehicle Inspection Mechanic Licence, contact:

The Director
Alberta Transportation
Vehicle Safety
Vehicle Safety and Carrier Services Branch
Main Floor, Twin Atria Building
4999 – 98 Avenue
Edmonton, Alberta T6B 2XB
780-427-8901

For toll-free service from anywhere in Alberta, dial 310-0000.

Chapter 3

Operating Buses



3

Operating Buses

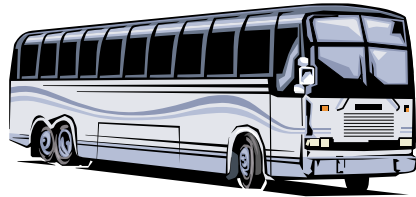

The holder of a Class 2 operator's licence may operate:

- a bus
- any motor vehicle or combination of vehicles that the holder of a Class 3, 4 or 5 operator's licence may operate
- Class 1 and 6 type vehicles for learning only.

Information for Class 2 and Class 4 bus operators

While the following information may apply to various types of buses, it is primarily about the operation of school buses. If you drive a bus, even if it is not a school bus, you should still read this section carefully. Most of the facts and procedures that follow apply to all bus operations.

As a bus operator you are responsible for the safe transportation of a large number of passengers, regardless of weather, road or traffic conditions experienced during the trip. That responsibility exists whether the bus you drive is a commercial, school or private bus. You must have the skills to adjust quickly to changing conditions both inside and outside the bus.

Know all the rules and regulations under which you operate, including company policy.

Vehicle inspections

A vehicle inspection will identify systems or parts of a vehicle that:

- are not working properly
- have already failed
- are missing components.

Remember, even if bus maintenance is the shop's job, once the bus is on the road, it is your responsibility. Inspect the bus before starting out and never take out a bus when a problem has been found that may affect its ability to operate safely.

3

Pre-trip inspection

Spending five to 10 minutes a day on a pre-trip inspection is worth it if it prevents a breakdown. Make it a habit and do it the same way each time.

Remember that a vehicle pre-trip inspection is required as part of the road test when applying for a Class 2 operator's licence.

The following detailed pre-trip inspection is a guide for reference only. Check with your employer to determine if the company has its own forms for recording vehicle condition reports.

Before beginning the inspection

- Choose terrain that is as level as possible and park the vehicle safely away from traffic.
- Set the parking brake. Place the manual transmission in low gear, or in park for an automatic transmission.
- Shut off the engine.
- Block the wheels to keep the vehicle from moving.

Circle check for a bus

The following diagram shows one way to perform a full circle check of a school bus. Do a walk-around check before starting any trip. The order of the check can be changed, but make sure everything is checked and always make a complete circle around the vehicle.

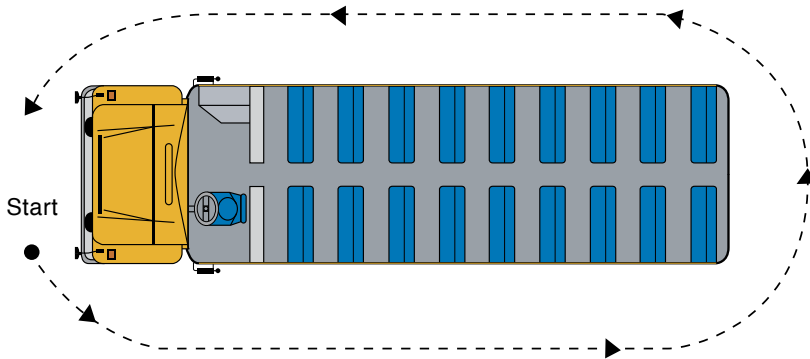

Daily walk-around procedure – items to check

Starting at the front of the vehicle and going down the left side of the vehicle, from the front to the back, facing the direction of an approaching vehicle, check the following.

Outside of the bus

Under the hood

- radiator has no leaks, has adequate coolant level and a proper fitting cap
- fan has no bent, cracked, missing blades or loose mountings
- all belts have correct tension and do not show signs of wear
- oil and other fluid levels are adequate
- air filter for condition
- shock absorbers are not loose or leaking
- battery has no cracks, excessive corrosion or leaks, terminal connections are secure, battery is securely mounted (battery location may vary on each bus)
- suspension has no cracked, missing or broken leaf springs, or loose, missing or broken U-bolts

3

- all hose connections are secure, have no leaks, kinks, cuts, abrasions or cracks
- steering system has no bent, broken or missing parts, power steering pump and hose for leaks and adequate fluid level.

Note: During the pre-trip inspection, return to the driver's compartment as required to turn the lights on and off to check that they are working properly.

Front of the bus

- no traces of leaking fluids on the ground under the vehicle
- high and low beam headlights work, lenses are clean and not cracked
- hazard warning lights work, lenses are clean and not cracked
- right and left turn signals work, lenses are clean and not cracked
- alternating amber and red flashing lights work, lenses are clean and not cracked, (some school buses may not be equipped with alternately flashing amber lights)
- pedestrian-student safety crossing arm is secure, not damaged and works (some school buses may not be equipped with a pedestrian-student safety crossing arm)
- clearance and marker lights work, lenses are clean and not cracked, reflectors are clean
- cross over mirror is secure, clean and not cracked.

Left side of the bus

- steering axle tire has adequate tread depth, proper inflation, no bulges, sidewall separation, cuts or uneven wear
- steering axle rim has no cracks, missing pieces, bends or rust streaks, wheel fasteners are secure and not missing, broken or loose
- oil level in steering axle wheel bearing if equipped
- mirrors are attached securely, clean and not cracked
- stop arm is secure and not damaged (some school buses may not be equipped with a stop arm)
- body has no damage, broken or missing rivets, holes or weld separations
- clearance and marker lights work, lenses are clean and not cracked, reflectors are clean
- windows are clean
- drive axle tires have adequate tread depth, proper inflation, no bulges, sidewall separation, cuts or uneven wear, dual tires are not touching and nothing is trapped between them
- drive axle wheel rims have no cracks, missing pieces, bends or rust streaks, wheel fasteners are secure and not missing or broken
- suspension has no cracked, missing or broken springs, not loose, missing or broken U-bolts.

3

Rear of the bus

- right and left turn signals work, lenses are clean and not cracked
- hazard warning lights work, lenses are clean and not cracked
- brake lights and backing lights work, lenses are clean and not cracked (whenever possible, have another person activate the controls while you check for proper operation)
- alternating amber and red flashing lights work, lenses are clean and not cracked
- clearance and marker lights work, lenses are clean and not cracked, reflectors and retro-reflective tape, if present, are clean
- licence plate is clean, securely attached, registration decal is valid, licence plate light works and is clean
- windows are clean
- rear door opens properly, closes securely, emergency buzzer works and rear door seal is not damaged
- exhaust system is in good condition, has no leaks, muffler is securely attached
- mud flaps are secure and do not rub the tires
- specialized equipment for transporting persons with disabilities is operating and is secured properly, if equipped
- spare tire, if equipped, is inflated and secure, jack and tools are properly secured.

Right side of the bus

Continue inspecting the right side using the same procedures as on the left side and add:

- fuel filler cap is present and secure
- passenger door operates smoothly and closes securely from the inside
- steps are clean and step light works, if equipped
- inspection decal is present, valid and in correct location.

In the cab and engine start up

- seat and mirrors are adjusted properly
- seat belt is adjusted and fastened properly
- feel and operation of clutch pedal, if equipped
- windows are clean, windshield is clean and free of major cracks
- all gauges and warning lights work
- all lights work
- fuel level is adequate
- windshield wipers work, washer has adequate fluid and sprays well
- defroster, heater work properly
- steering does not have excessive play or slack
- horn works
- service brakes have been tested by driving forward slowly and stopping
- parking brake works (for vehicles equipped with air brakes, refer to the air brake section in Chapter Two of this handbook)
- stop arm and lights work, if equipped

3

- all necessary documentation is in the vehicle. This includes the vehicle registration and valid insurance, Commercial Vehicle Inspection Program (CVIP) inspection certificate, any necessary authorities, permits and logbook, if required, are valid
- there are no unusual engine noises.

Inside the bus

- handrail is secure
- fire extinguisher is fully charged and label indicates that it is valid, approved warning devices are present
- first aid kit is fully equipped
- all emergency exits open and close properly and the alarm system is working
- passenger seats are securely fastened to the floor and are in good condition
- the interior for cleanliness and damage
- restraints for the wheelchair work and are secured, if equipped.

Post-trip inspection

A school bus is subject to considerable wear and tear. It travels in poor weather conditions, often over difficult roads, and is usually full of lively children. For this reason, it is important that you inspect the bus both inside and outside at the end of every trip.

You need to:

- inspect the bus for lost articles and children who are sleeping or still on the bus
- clean the floors, particularly around the front steps
- check the condition of the emergency equipment
- report any minor damage and fluid leaks under the bus
- check the tires for damage and air leaks.

Breakdowns

Even if a walk-around of the bus is done daily and a regular maintenance schedule is followed, the bus may break down when you least expect it. If this happens on the road, do the following.

- If possible, stop the bus in a safe place as far off the roadway as practical.
- Analyze the situation. If the bus is stopped in a dangerous location, get the passengers off the bus and guide them to a safe location. If there is no danger, it is usually safer if the passengers stay on the bus.
- If a breakdown occurs, and the vehicle is stationary on a highway outside the limits of an urban municipality during the period between sunrise and sunset (during the day), activate the emergency hazard lights. Place approved warning devices 30 metres (about 100 feet) in front of and behind the bus.
- If a breakdown occurs, and the vehicle is stationary on a highway outside the limits of an urban municipality during the period between sunset and sunrise (in darkness), or anytime when there is not sufficient light to see people or vehicles clearly on a highway at a distance of 150 metres, activate the emergency hazard lights. Place approved warning devices 75 metres (about 250 feet) in front of and behind the bus.

3

- If you cannot fix the problem quickly or cannot radio or phone for help, stay with the bus. Subject to school board policy, you may consider sending two responsible students for help. Be sure to put in writing the information they will need to give others.
- If the distance or weather makes it dangerous to send students, have everyone stay with the bus and try to flag down a passing vehicle or wait until help arrives.

Passenger loading and unloading

School bus operators should follow these procedures.

- The law requires that the alternately flashing red lights and stop arm **only** be used when loading and unloading passengers. The driver must know when the alternately flashing lights must be used. Local authorities may prohibit or restrict their use. **All drivers must activate the alternately flashing lights when loading and unloading passengers, except when operating on a roadway where a bylaw prohibits their use.**
- Drivers of vehicles must stop when approaching a stopped school bus displaying alternately flashing red lights from either direction on an undivided highway, and from behind the bus on a divided highway.
- On buses equipped with the eight-light system, the alternately flashing amber lights shall be activated as the bus begins to slow down for the stop. Where possible, minimize traffic disruption by allowing vehicles to pass before turning on the alternately flashing red lights.
- Pull as far to the right as practical before stopping to load or unload passengers. Choose a location that allows safe footing and is at least one metre away from the students waiting to board. The law allows a driver to stop on the roadway if a suitable and safe location off the roadway is not available.

- Activate the alternately flashing red lights when the bus comes to a complete stop. The alternately flashing lights must not be used when the bus is not involved in loading or unloading passengers.
- Before loading or unloading, check that all traffic has stopped, that the transmission is in neutral for a manual transmission, or park for an automatic and the park brake is applied. Keep firm pressure on the brake pedal.
- Open the door of the bus and let the passengers on or off.
- If students must cross the highway in a rural area after getting off the bus, instruct them to go at least 10 paces in front of the bus, stop before they enter the roadway and wait for your direction before crossing the road. Establish a line of sight with them; look up and down the roadway checking for traffic before you let them cross in front of the bus. Do not lose sight of the students as they cross and be sure that you can account for all of them.
- Before moving, check all mirrors, including the cross over mirror, to ensure that no students are lingering near the bus.
- Turn off the alternately flashing lights after all the students are seated, release the park brake, and when it is safe signal left and re-enter the traffic flow.

Drivers must also be aware of the following.

- The bus must not be moving while students enter or exit.
- It is against the law to back a school bus in a schoolyard without guidance from a responsible person located outside and at the rear of the bus. You must be able to see the guide at all times. You are responsible for all your movements.

3

- Be sure that all the students are seated while the bus is in motion.
- Never exceed the seating capacity of the bus.
- Always use frequent mirror checks to be sure that it is safe before activating the alternately flashing red lights or giving a signal for the students to cross the roadway. Even though other drivers are required by law to stop, they may not.
- If a driver of a vehicle does not stop for the alternately flashing red lights, write down the vehicle's licence plate number and report the incident immediately to the local police authority and your supervisor.

Railway crossing procedures for school bus operators

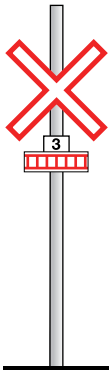

Railway crossings present a special hazard because any time is train time. Know the railway crossing laws and school board policy, as well as municipal bylaws.

By law, as a driver of a school bus, you are required to stop at a railway crossing unless:

- the crossing has a traffic control signal, lights and bell, or
- a peace officer or flagman directs you to proceed.

The following procedures apply at all uncontrolled railway crossings.

- There should be no excess noise from the bus. Turn off any fans or radios that are working and ask the passengers to be quiet.
- If in the left lane of a multi-lane highway, signal and change to the far right lane well in advance of the crossing.
- Check for traffic behind. The alternately flashing amber or red lights must not be used when stopping at a railway crossing.
- Stop not less than five metres or more than 15 metres from the nearest track.
- Put a manual transmission in neutral. For an automatic transmission, engage the parking brake and keep firm pressure on the brake pedal.
- Open the front door and the driver's window. Look both ways and listen for an approaching train. If you see or hear a warning signal or train whistle and do not see a train coming, do not cross the tracks until you know it is safe to do so. If bright sunlight, fog, snow or smoke make it hard to see, walk to the track to see if you can cross it safely.
- Remember, as the driver of the school bus, you must never leave the bus without turning off the engine, setting the brakes, putting the transmission in its lowest gear (manual) or park (automatic) position and taking the key out.
- When you are sure that it is safe to proceed, select an appropriate low gear.

3

- Release the park brake.
- Check left and right.
- Close the door.
- Cross the tracks.
- If the transmission is manual, do not shift gears until you are clear of the last track.

Reversing (backing)

Reversing a school bus is a leading cause of school bus collisions. It should be avoided whenever possible. It is illegal to reverse a loaded or unloaded school bus in a schoolyard or at a location next to a school ground unless there is a responsible guide located outside at the rear of the bus giving direction. Remember that you are responsible for all movements of the bus. Here are some guidelines to follow.

- Physically check the area for any obstructions and clearances.
- Have a responsible adult act as a guide.
- Agree on the hand signals that will be used.
- Tell the person where to stand.
- Tap the horn.
- Reverse slowly.
- Stop immediately if you lose sight of the guide.
- Remember, even with a guide, you are still responsible for all movements of the bus.

When required to reverse, other than on school property, make sure the area is clear of obstructions and use both side mirrors.

Turnarounds

Some bus routes may require a driver to do a turnaround. The only time a turnaround should ever be done on a two-lane highway is if it cannot be done on private property. Turnarounds are done by backing into a road on the right of the main roadway. Never back onto or across a highway. When a turnaround must be done, the following procedure is recommended.

- Start slowing down well in advance of the turnaround.
- Stop the bus in the proper position on the main roadway. It should be about one bus length ahead of the road that you will be reversing into. Check traffic in all directions to ensure that there is enough time and space in the traffic to allow the turnaround. Wait for traffic to pass around you if possible.
- Back into the road on the right when it is clear, using your mirrors and shoulder checking to the right.
- Re-enter the main roadway when it is clear and safe to do so.

Remember, never back onto or across a highway.

3

If required to load or unload passengers at the turnaround point, do the following.

- Load the passengers **before** the turnaround (see 1 and 2 on the diagram).
- Unload the passengers **after** backing (see 3 and 4 on the diagram).

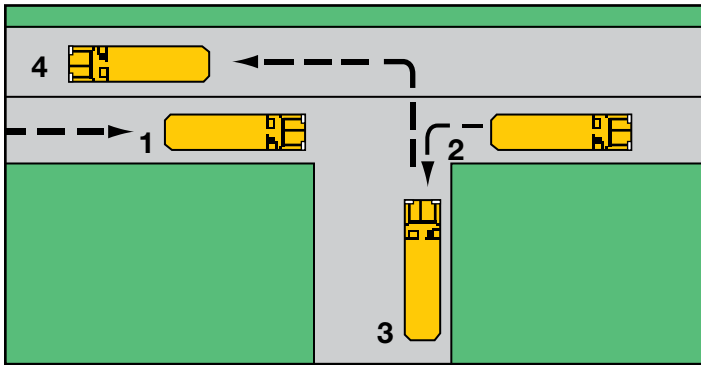

A U-turn may only be done on a four-lane divided highway if the length of the bus is less than the width of the median separating the flow of traffic.

The bus must be brought to a full stop on the crossroad. The front and back of the bus must be clear of all traffic lanes.

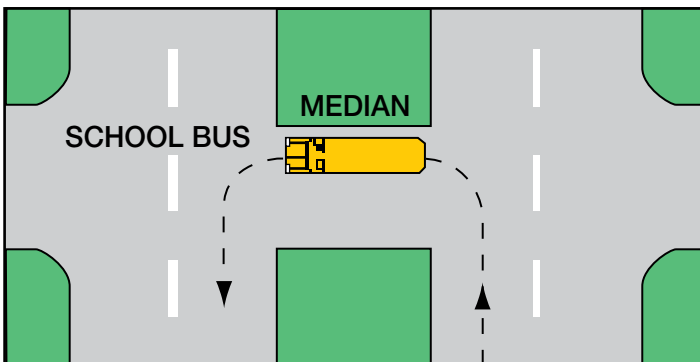

Parking on a hill



The law requires that the wheels of a parked vehicle be no more than 50 centimetres from the curb. When parked, the vehicle must be left in low gear or reverse for a manual transmission or park for an automatic transmission. Have the park brake engaged. The following information applies to vehicles parked on the right-hand side of the road. For vehicles parked on the left-hand side of the road (one-way), turn the front wheels in the opposite direction.

- For parking downhill, with or without a curb, the front wheels should always be turned to the right.
- For parking uphill with a curb, the front wheels should always be turned to the left.
- For parking uphill without a curb, single unit vehicles should always have their front wheels turned to the right.

Note: If there is a curb, allow the vehicle to roll to the point where the front tire closest to the curb is making contact with the curb before setting the park brake. This helps to prevent the vehicle from jumping the curb if the vehicle starts to move.

Discipline and problem solving

You are not only responsible for the safety of your passengers, but also for dealing with their behaviour while they are in the bus. Many discipline problems are also safety problems and should be handled quickly and efficiently. Remember, regardless of any problems that you may have with a student, you **cannot** unload the student at any place other than the student's normal destination. Only the school administration may remove or prohibit a student from riding a school bus.

3

Safe driving guidelines

- The maximum speed limit for a loaded or unloaded school bus, under ideal conditions, is 90 km/h or the posted speed limit, whichever is lower.
- Do not try to make up lost time by travelling faster than is reasonable for road conditions or the law allows.
- When following another vehicle, always allow enough of a space cushion. Use the four-second following rule and increase this distance when the road or weather conditions are poor or when it is difficult to see.
- Make sure all students are seated and remain seated while the bus is moving. Everyone must enter or leave the bus by the front door. The rear door, by law, should not be used unless there is an emergency. You and your passengers should know about the emergency exits, emergency equipment and evacuation procedures.
- All doors must be closed when the bus is moving.
- When moving away from the curb, use caution, as you do not have the right-of-way.
- When crossing a highway, do not proceed until the traffic is clear in both directions.
- Never refuel a bus with passengers aboard.
- Establish a good relationship with your passengers. Your job will be safer, easier and more enjoyable.
- At the beginning of the school year it is a good idea to hold an evacuation drill with everyone who rides the bus. This way, the passengers will know what to do in case of a real emergency. Hold the drill in a safe traffic-free area on, or next to the school property. Work with the school administration to set up the drill.

- There are three standard methods to evacuate the bus, although other ways can be used in extreme situations. The three methods are: the front exit, the rear exit and the front and rear exit at the same time. In a real situation, you will need to assess the situation and choose the most appropriate method to exit.

Improve your qualifications and knowledge

- Drivers who have a Class 1, 2 or 4 licence can apply for the school bus driver endorsement condition code “S” to be placed on their licence when they successfully complete the School Bus Driver Improvement Program. For information on taking an approved School Bus Driver Improvement Program course, please contact:

Alberta Transportation

Driver Programs Administrator

Edmonton 780-427-8901 or Calgary 403-297-6679

For toll-free service from anywhere in Alberta, dial 310-0000.

Chapter 4

Operating Class 3 Vehicles



4

Operating Class 3 Vehicles

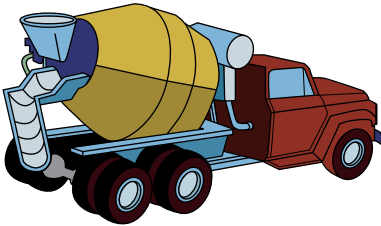
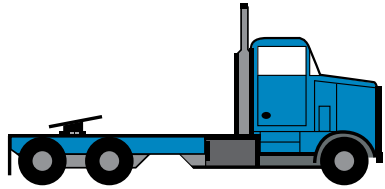
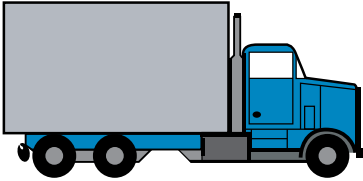

Examples of Class 3 motor vehicles are trucks designed for transporting goods or carrying loads.

The holder of a Class 3 operator's licence may operate:

- any motor vehicle or combination of vehicles that the holder of a Class 5 operator's licence may operate
- a single motor vehicle with three or more axles
- a single motor vehicle with three or more axles towing a trailer with one or more axles, if the trailer is not equipped with air brakes
- Class 2 or 4 type vehicles without passengers
- all Class 1, 2 and 6 type vehicles for learning only.

Pre-trip inspection

The purpose of a vehicle inspection is to identify systems or parts of a vehicle that are not working properly, have failed or are missing parts so that they can be replaced or repaired before they cause harm. Regular inspections decrease downtime and associated costs. These costs include fines, towing, travel and overtime of company mechanics, repair costs and delays when using local garages, as well as penalties and costs caused by late delivery of the load.

Remember that a vehicle pre-trip inspection is required as part of the road test when applying for a Class 3 operator's licence.

The following detailed pre-trip inspection is a guide for reference only. Check with your employer to determine if the company has its own forms for recording vehicle condition reports.

Before beginning the inspection

- Choose terrain that is as level as possible and park the vehicle safely away from traffic.
- Set the parking brake. Place the manual transmission in low gear, or in park for an automatic transmission.
- Shut off the engine.
- Block the wheels to keep the vehicle from moving.

4

Circle check for a single unit with three or more axles

This drawing shows one way of making a full circle check of the unit you are driving. A driver must do a walk-around check before starting any trip. The order of the check can be changed, but check everything that is required and always make a complete circle around the vehicle.

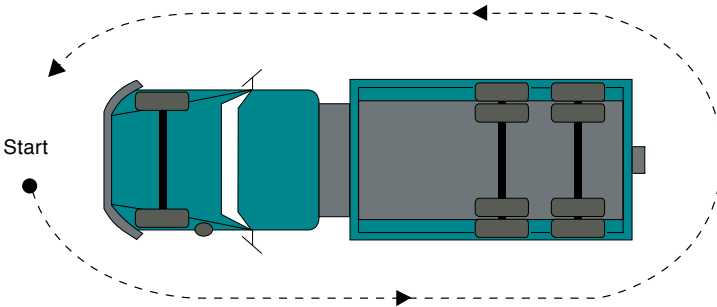

Daily walk-around procedure – items to check

Starting at the front of the vehicle and going down the left side of the vehicle, from the front to the back (facing the direction of an approaching vehicle) check the following.

Outside of the vehicle

Under the hood

- radiator has no leaks, has adequate coolant level and a proper fitting cap
- fan has no bent, cracked, missing blades or loose mountings
- all belts have correct tension and do not show signs of wear
- oil and other fluid levels are adequate
- battery has no cracks, excessive corrosion or leaks, terminal connections are secure, battery is securely mounted (battery location may vary on each vehicle)

- air filter for condition
- all hose connections are secure, have no leaks, kinks, cuts, abrasions or cracks
- shock absorbers are not loose or leaking
- suspension has no cracked, missing or broken leaf springs, or loose, missing or broken U-bolts
- steering system has no bent, broken or missing parts, power steering pump and hose for leaks and adequate fluid level.

Steering axle brakes, check

- brake chambers for condition and are secure
- slack adjuster angle, push rod travel, mechanical condition and wear
- air lines have no leaks, kinks, cuts, abrasions or cracks.

Front of vehicle

- no traces of leaking fluids on the ground under the vehicle
- high and low beam headlights work, lenses are clean and not cracked
- hazard warning lights work, lenses are clean and not cracked
- right and left turn signals work, lenses are clean and not cracked
- clearance and marker lights work, lenses are clean and not cracked, and reflectors are clean.

4

Left side of vehicle

- steering axle tire has adequate tread depth, proper inflation, no bulges, sidewall separation, cuts or uneven wear
- steering axle rim has no cracks, missing pieces, bends or rust streaks, wheel fasteners are secure and not missing, broken or loose
- oil level in steering axle wheel bearing, if equipped
- inspection decal is present, valid and in the proper location
- driver's door operates properly
- steps are secure and in good condition
- handrail is secure
- mirrors are attached securely and are not cracked
- fuel tank has no leaks, tank is secure, the air vent is not plugged and the proper fitting cap is secure
- fuel system lines are secure and have no leaks
- exhaust system is in good condition, has no leaks, muffler is securely attached, and heat shield, if present, is secure
- first drive axle tires have adequate tread depth, proper inflation, no bulges, sidewall separation, cuts or uneven wear, dual tires are not touching and nothing is trapped between them

- ❑ first drive axle wheel rims have no cracks, missing pieces, bends or rust streaks, wheel fasteners are secure and not missing or broken
- ❑ second drive axle tires have adequate tread depth, proper inflation, no bulges, sidewall separation, cuts or uneven wear, dual tires are not touching and nothing is trapped between them
- ❑ second drive axle wheel rims have no cracks, missing pieces, bends or rust streaks, wheel fasteners are secure and not missing, broken or loose
- ❑ suspension has no cracked, missing or broken springs, torsion bars or walking beams are secure and not damaged, no loose, missing or broken U-bolts. If there is air suspension, no cracked, worn or inoperative air bags, no loose or leaking shock absorbers, all mounting devices are in good condition
- ❑ axle assembly has no breaks, cracks, holes, broken seals or bends
- ❑ body has no damage, broken or missing rivets, holes or weld separations
- ❑ frame and structural supports have no holes, bends, cracks, weld separations or broken cross members
- ❑ clearance and marker lights work, lenses are clean and not cracked, reflectors are clean
- ❑ load security devices are holding the load safely and securely, anchor points are secure, vehicle and load devices are protected from damage.

4

Rear of vehicle

- right and left turn signals work, lenses are clean and not cracked
- hazard warning lights work, lenses are clean and not cracked
- brake lights and backing lights work, lenses are clean and not cracked (whenever possible, have another person activate the controls while you check for proper operation)
- clearance and marker lights work, lenses are clean and not cracked, reflectors are clean
- licence plate is clean, securely attached, registration decal is valid, licence plate light works and lens is clean
- doors or gate operate well and are securely closed
- mud flaps are secure and do not rub on the tires.

Right side of vehicle

Continue inspecting the right side of the unit using the same procedures as on the left side of the vehicle.

In the cab and engine start up

- seat and mirrors are adjusted properly
- seat belt is adjusted and fastened properly
- brake pedal and clutch pedal, if equipped, feel and operate correctly
- all gauges and warning lights work
- fuel level is adequate
- windows are clean and windshield is clean and free of major cracks
- windshield wipers work, washer has adequate fluid and sprays well

- defroster and heater work properly
- steering does not have abnormal play or slack
- horn and backing alarm work properly
- the engine runs smoothly
- there is no unusual noise when the clutch is pushed in and then released while the engine is running and the transmission is in neutral.

Extra equipment and documentation

- fire extinguisher is fully charged and label indicates that it is valid, approved warning devices are present
- first aid kit is fully equipped
- all necessary documentation is in the vehicle. This includes the vehicle registration and valid insurance, Commercial Vehicle Inspection Program (CVIP) inspection certificate, any necessary operating authorities, permits and logbook, if required, are valid
- all personal protective equipment that is required before going on to a work site is present
- tools are properly secured
- spare light bulbs, fuses, belts are present.

4

Parking on a hill



The law requires that the wheels of a parked vehicle be no more than 50 centimetres from the curb. When parked, a vehicle with a manual transmission must be left in low gear or reverse. For an automatic transmission put the vehicle in park and have the park brake engaged. The following information applies to vehicles parked on the right-hand side of the road. For vehicles parked on the left-hand side of the road (one way), turn the front wheels in the opposite direction.

- When parking downhill, with or without a curb, the front wheels should always be turned to the right.
- When parking uphill, with a curb, the front wheels should always be turned to the left.
- When parking uphill, without a curb, single unit vehicles should always have their front wheels turned to the right.

Note: Where there is a curb, allow the vehicle to roll to the point where the front tire closest to the curb is making contact with the curb before setting the park brake. This helps to prevent the vehicle from jumping the curb in the event the vehicle starts to move.

Loading and unloading dump vehicles



Loading

Follow your company's policy for loading a vehicle on site. Some companies prefer drivers to remain inside the vehicle while others require them to stand outside the vehicle while it is being loaded.

When leaving the vehicle, use the three-point contact procedure. This means that two hands and one foot or two feet and one hand remain on the vehicle at all times. Never jump from the vehicle. When outside the vehicle, wear the appropriate protective equipment.

You must not move a loaded vehicle until the following has occurred.

- The material is evenly distributed in the box.
- The load is secured so it will not blow or fall off and damage other vehicles or cause personal injury. You must comply with the *Traffic Safety Act* when securing loads. If a municipality has a law that states that the load must be tarped, you must ensure that it is done. While covering the load, watch for debris that may have been caught in the tarp.
- The vehicle's tailgate, tailboards, doors, tarpaulins, spare tire and any other equipment that needs to be fastened are secured.
- There are no loose materials, debris or rocks in the tailgate, sides of the box, hitches or coupling devices. Clean or sweep off loose material with a brush or broom.
- The vehicle is loaded so the total dimensions and total weight on each axle are within the limits according to the laws in the jurisdiction where the vehicle is being operated.

4

Before unloading

- Move slowly if you must back into a position to unload. Before backing in an unfamiliar area, get out, look around the area and walk the route that you will follow.
- You should back the vehicle to the driver's side (left) for better visibility. Use the mirrors continually to check your position.
- If the vehicle is equipped with a backing alarm, make sure it is working. Some regulations require a backing alarm when vehicles are around workers on foot. These alarms must be automatic and can not have a shutoff switch as specified in *Alberta Regulation 44/83 Occupational Health and Safety Act, General Safety Regulation 104(1)*.
- Whenever possible, have someone guide the vehicle when you are unloading. Make sure that you and the guide use and understand the same hand signals. The guide should always be outside and to the rear of the vehicle so that he or she is able to see the path the vehicle is taking and can be seen by the driver. The driver should always be able to see the guide. Stop if you can not see the guide.
- Remember, even with a guide, you are still responsible for all movements of the vehicle.
- Check for overhead wires and obstructions.
- Do not raise the box to dump unless the vehicle is on level ground.

During unloading

- Check your operator's manual for detailed instructions for unloading.
- Other vehicles and people must not be within the dumping radius of the raised box.
- Before dumping into a hopper, get out and look to make sure the hopper is empty.
- To avoid a tip-over, learn to recognize hazardous areas and situations. These include soft or uneven surfaces or poorly compacted fill.
- Remember that the angle of the truck bed will regulate how fast the material flows from the box.
- Release the tailgate. Be aware that a load that is concentrated at the rear of a raised box with the tailgate closed can tip the vehicle over backwards.
- Do not get into the raised box if the load is stuck. Lower the box first.
- If you use a guide and lose sight of him, stop until visual contact is regained.
- Once the unloading has been completed, lower the box and ensure that the tailgate is latched.

4

Mixer truck operators

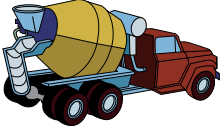

Mixer trucks in the Class 3 vehicle category require the same basic procedures for pre-trip inspections noted in the previous section, except for the specific characteristics of that vehicle. Although loading and unloading the product would be different, similar safety precautions are needed, as well as the assessment of the conditions at each job site. The vehicle driver is responsible for the truck at all times.

Concrete mixers are top heavy and unstable when loaded. Due to the rotating action of the mixer drum and the unique characteristics of concrete, special care is needed when carrying low slump concrete on turns, corners and ramps.

Chapter 5

Operating Class 4 Vehicles

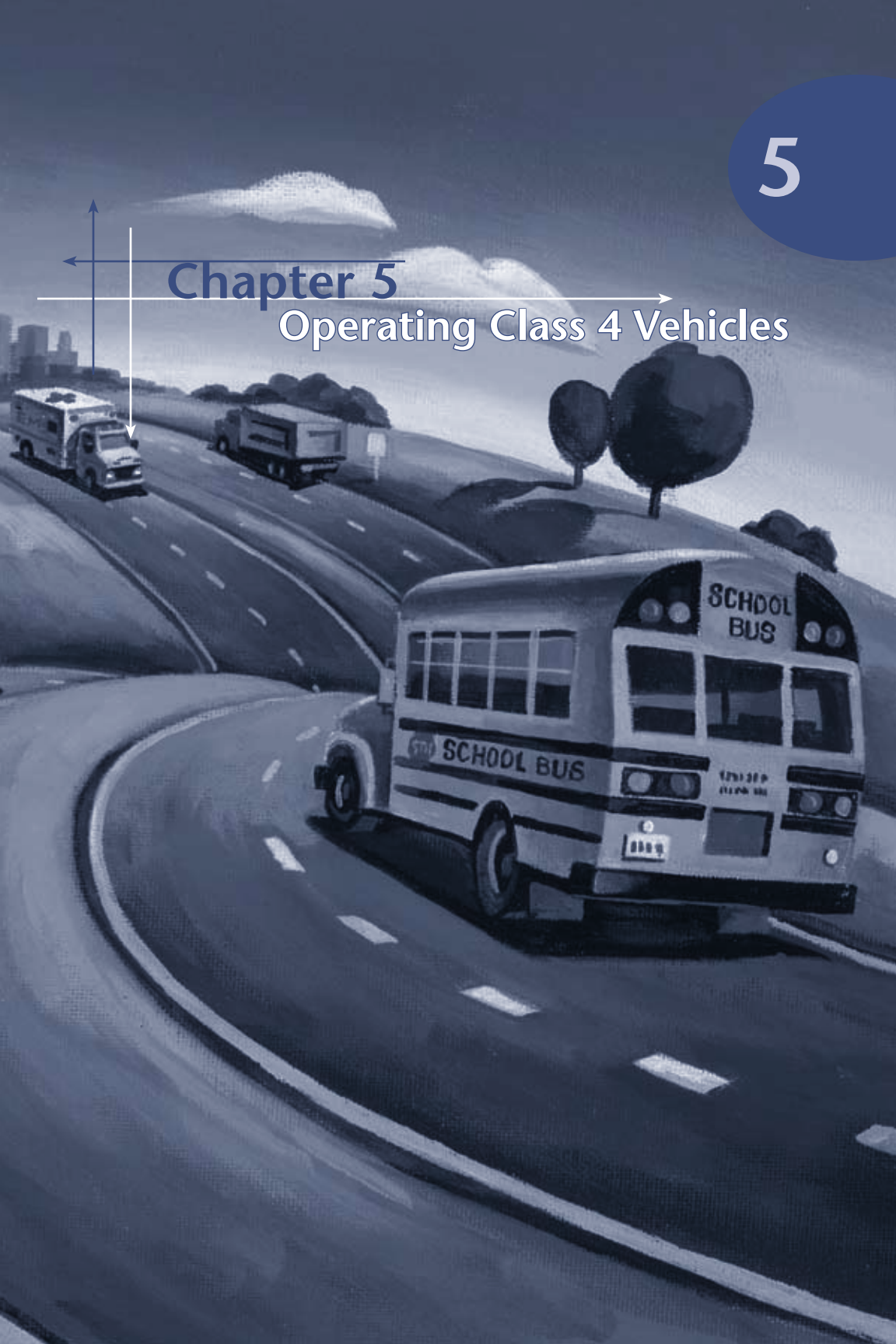

5

Operating Class 4 Vehicles

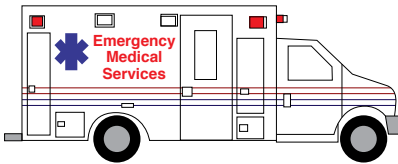

Examples of Class 4 motor vehicles are ambulances, taxis, buses with a seating capacity of less than 24 passengers, and vehicles being used for hire. For other vehicles operating under the conditions for hire, see the section on *Other uses for a Class 4 licence* at the end of this chapter.

The holder of a Class 4 operator's licence may operate:

- any motor vehicle or combination of vehicles that the holder of a Class 5 operator's licence may operate
- a bus that has a seating capacity of not more than 24, excluding the driver
- an ambulance or taxi
- all Class 1, 2, 3 and 6 type vehicles for learning only.

Note: The holder of a Class 5 operator's licence shall not operate a motor vehicle transporting passengers for hire. This requires a Class 4 operator's licence.

Ambulance vehicles

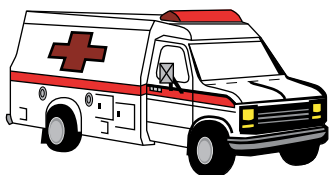

Legal aspects of ambulance operation

- *The Traffic Safety Act states that a siren on an emergency vehicle shall be operated only when the vehicle is being used in response to an emergency, an emergency call or an alarm.*
- *When operating an emergency vehicle, the law states:*
 - (1) Where, considering the circumstances, it is reasonable and safe to do so, a person driving an emergency vehicle may while the vehicle's siren is operating do one or more of the following:*
 - (a) drive the vehicle in excess of the speed limit;*
 - (b) proceed past a traffic control signal indicating stop or a stop sign without stopping;*
 - (c) contravene any provision that is prescribed by the Act, this or other regulations or a municipal bylaw governing the use of the highways.*
 - (2) An emergency vehicle, while its siren is operating, has the right of way over all other vehicles.*
- *Use of the red flashing lights alone does not exempt the driver from the Traffic Safety Act.*

5

- The *Traffic Safety Act* authorizes emergency medical operators to disregard some traffic laws under limited circumstances. Failure to meet the requirements of these circumstances means that the driver may be subject to Civil and Criminal penalties in the event of a collision.
- Even during the most serious emergency, an emergency medical operator must consider the safety of others.
- When parking an emergency vehicle, the law states:
Where, considering the circumstances, it is reasonable and safe, an emergency vehicle may, while its flashing lights are operating, be parked contrary to any provision that is prescribed by the Act, this or other regulations or a municipal bylaw governing the parking of motor vehicles.

Pre-trip inspection

It is an important practice to check the condition of the vehicle before a call comes in and you need to take it out. Doing a pre-trip inspection will assist you in finding any defects or equipment that is not working. Do not take the vehicle out until the problem has been repaired.

The following detailed pre-trip inspection is a guide for reference only. Check with your employer to determine if the company has its own forms for recording vehicle condition reports.

Before beginning the inspection

- Choose terrain that is as level as possible and park the vehicle safely away from traffic.
- Set the parking brake. Place the manual transmission in low gear, or in park for an automatic transmission.
- Shut off the engine.

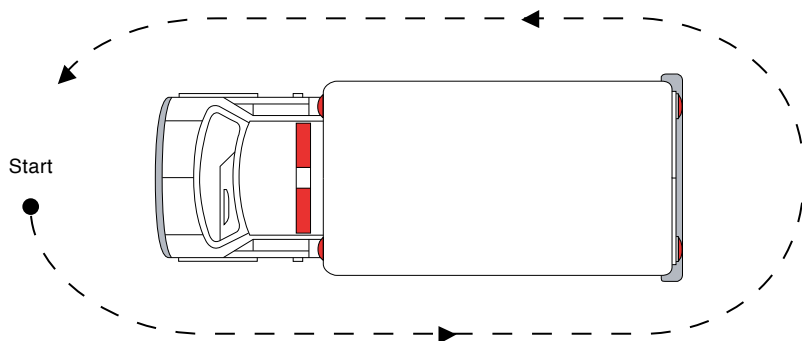

Daily walk-around procedure – items to check

Starting at the front of the vehicle and going down the left side of the vehicle, from the front to the back (facing the direction of an approaching vehicle) check the following.

Outside of the vehicle

Under the hood

- radiator has no leaks, has adequate coolant level and a proper fitting cap
- fan has no bent, cracked, missing blades or loose mountings
- all belts have correct tension and do not show signs of wear
- oil and other fluid levels are adequate
- battery has no cracks, excessive corrosion or leaks, terminal connections are secure, battery is securely mounted
- air cleaner for condition
- all hose connections are secure, have no leaks, kinks, cuts, abrasions or cracks
- steering system has no bent, broken or missing parts, power steering pump and hose for leaks and adequate fluid level.

5

Front of vehicle

- no traces of leaking fluids on the ground under the vehicle
- high and low beam headlights work, lenses are clean and not cracked
- hazard warning lights work, lenses are clean and not cracked
- emergency lights work, lenses are clean and not cracked
- clearance lights work, lenses are clean and not cracked
- right and left turn signals work, lenses are clean and not cracked
- windshield is clean and free of major cracks.

Left side of vehicle

- steering axle tire has adequate tread depth, proper inflation, no bulges, sidewall separation, cuts or uneven wear
- steering axle rim has no cracks, wheel fasteners are secure and not missing
- outside mirror is secure and not cracked
- side window is clean
- driver's door operates properly
- clearance and marker lights work, lenses are clean and not cracked, reflectors are clean
- fuel cap is present and secure (fuel cap location may vary on each vehicle)
- drive axle tire has adequate tread depth, proper inflation, no bulges, sidewall separation, cuts or uneven wear, dual tires if equipped are not touching and nothing is trapped between them
- drive axle wheel rim has no cracks, wheel fasteners are secure and not missing.

Rear of vehicle

- right and left turn signals work, lenses are clean and not cracked
- hazard warning lights work, lenses are clean and not cracked
- brake lights and backing lights work, lenses are clean and not cracked (whenever possible, have another person activate the controls while you check for proper operation)
- licence plate is clean, securely attached, registration decal is valid, licence plate light works and lens is clean
- rear step lights work, lenses are clean and not cracked
- emergency lights work, lenses are clean and not cracked
- floodlights work, are clean and not cracked
- rear doors open and close properly
- exhaust system is secure and has no visible leaks.

Patient compartment

- medical equipment is stowed properly and inventory is completed
- fire extinguisher is fully charged and label indicates that it has not expired, approved warning devices are present.

Right side of vehicle

Continue inspecting the right side of the vehicle using the same procedures as on the left side of the vehicle.

5

In the cab and engine start up

- seat and mirrors are adjusted properly
- seat belt is adjusted and fastened properly
- all gauges and warning lights work
- fuel level is adequate
- radio equipment and P. A. system work
- siren works in all modes
- windshield wipers work, washer has adequate fluid and sprays well
- horn works
- defroster and heater work properly
- there are no unusual engine noises.

Defensive driving factors

Headlights

Always use headlights along with the emergency overhead lights.

Lights and sirens

Sirens are required by law when an ambulance is operating during an emergency. Using the red flashing overhead lights alone is not sufficient. Do not let the emergency sirens and lights give you a false sense of security. These warning devices are for the benefit of the public. Most drivers will clear the path if they know the ambulance is there. Do not assume that other drivers have seen your vehicle or that they will move out of the way. The responsibility for safe driving rests on you, the emergency medical operator.

Other factors

As an emergency medical operator, it is important to identify those situations that could result in a collision. Driving movements that can contribute to collisions are:

- backing
- poor road position
- turning
- changing lanes
- lack of awareness of the unit size that can lead to side swipes on the blind right side
- driving too fast for conditions.

If you approach an intersection with cross traffic, slow down and if practical, stop briefly. Make eye contact with the other drivers at the intersection and proceed when you have been seen by them. Be even more careful at pedestrian crossings. Many pedestrians, including school children, may not be aware that an ambulance is coming toward them.

If you are driving on a four-lane highway with the lights and siren activated, stay in the left lane if possible.

When reaching the scene of a collision, park the vehicle so it protects the injured person(s) and the attendant. Keep the flashing lights activated and the headlights on so that the vehicle is clearly visible to other drivers.

5

Operating a taxi



As the driver of a taxi, your first and most important concern is safety. You will encounter numerous challenges in the driving task, and will need to be aware of other road users and their driving. To handle this effectively, keep your temper, be patient and drive proactively. To help you focus on your driving, ensure that nothing in the vehicle, including the passengers, prevents you from doing your job. It is your responsibility to provide safe transportation to all your customers. However, you may refuse to transport customers if:

- your vehicle is already carrying the maximum allowed number of passengers
- a passenger is offensive or dangerous to you or others.

Good professional habits go hand in hand with good passenger relations. To passengers, reliable and expert service means getting them to where they are going safely and comfortably, by the most direct route.

Taxi or limousine permits

Municipalities have different requirements for issuing a taxi permit. Check with your municipality about the requirements needed to obtain a taxi or limousine permit.

Note: Always check municipal laws regarding taxi operation.

Pre-trip inspection

Always check the condition of your vehicle before taking it out for a day's work. Conducting a pre-trip inspection of your vehicle may assist you in finding any defects or equipment that is not working. If a problem is found, do not take the vehicle out until it has been repaired.

The following detailed pre-trip inspection is a guide for reference only. Check with your employer to determine if the company has its own forms for recording vehicle condition reports.

Before beginning the inspection

- Choose terrain that is as level as possible and park the vehicle safely away from traffic.
- Set the parking brake. Place the manual transmission in low gear, or in park for an automatic transmission.
- Shut off the engine.

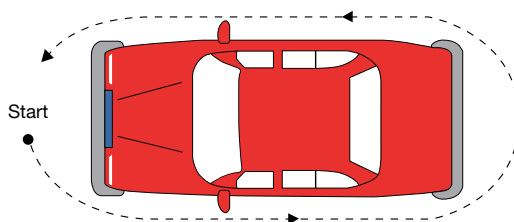

Daily walk-around procedure – items to check

Starting at the front of the vehicle and going down the left side of the vehicle, from the front to the back (facing the direction of an approaching vehicle) check the following.

5

Outside of the vehicle

Under the hood

- radiator has no leaks, has adequate coolant level and a proper fitting cap
- fan has no bent, cracked, missing blades or loose mountings
- all belts have correct tension and do not show signs of wear
- oil and other fluid levels are adequate
- battery has no cracks or excessive corrosion, terminal connections are secure, battery is securely mounted
- air cleaner for condition
- steering system has no bent, broken or missing parts, power steering pump and hose for leaks and adequate fluid level.
- all hose connections are secure, have no leaks, kinks, cuts, abrasions or cracks.

Front of vehicle

- no leaks on the ground under the vehicle
- high and low beam headlights work, lenses are clean and not cracked
- hazard warning lights work, lenses are clean and not cracked
- right and left turn signals work, lenses are clean and not cracked
- windshield is clean and free of major cracks.

Left side of vehicle

- steering axle tire has adequate tread depth, proper inflation, no bulges, sidewall separation, cuts or uneven wear
- steering axle rim has no cracks, wheel fasteners are secure and not missing

- outside mirror is secure and not cracked
- side windows are clean
- all doors operate properly
- fuel cap is present and secure (fuel cap location may vary on each vehicle)
- rear axle tire has adequate tread depth, proper inflation, no bulges, sidewall separation, cuts or uneven wear
- rear axle wheel rim has no cracks, wheel fasteners are secure and not missing.

Rear of vehicle

- right and left turn signals work, lenses are clean and not cracked
- hazard warning lights work, lenses are clean and not cracked
- brake lights and backing lights work, lenses are clean and not cracked (whenever possible, have another person activate the controls while you check for proper operation)
- licence plate is clean, securely attached, registration decal is valid, licence plate light works and lens is clean
- rear window is clean
- trunk opens and closes properly
- spare tire is properly inflated, secure and all necessary tools are stowed properly
- exhaust system is secure and has no visible leaks.

5

Right side of vehicle

Continue inspecting the right side of the vehicle using the same procedures as on the left side of the vehicle.

In the vehicle and engine start up

- seat and mirrors are adjusted properly
- seat belt is adjusted and fastened properly
- all gauges and warning lights work
- fuel level is adequate
- radio equipment works
- windshield wipers work, washer has adequate fluid and sprays well
- horn works
- defroster and heater work properly
- there are no unusual engine noises.

Reporting defects or incidents

You must report any defect or problem with the vehicle that could make it unsafe. Follow your company's policy for the proper procedure and required reports to be filled out.

You must end your trip if the vehicle develops a problem that could endanger the safety or comfort of any of the passengers. If you can fix the problem or have the danger removed, then continue with the trip. If not, make arrangements through your dispatcher to transport the passengers in another vehicle to their destination as soon as possible.

Report all incidents and collisions to your dispatcher or supervisor. Be aware of the company's policy regarding the procedures required.

Fuelling a vehicle



Do not fuel a vehicle when the engine is running or the radio transmitter is on. A vehicle should not be fueled when passengers are on board. Be sure there is sufficient fuel for the trip before picking up your passengers.

Seat belts

According to Alberta law, all drivers and passengers are required to use seat belts where the assemblies are provided. However, the driver of a taxicab is exempt from wearing a seat belt while carrying a passenger for compensation or hire.

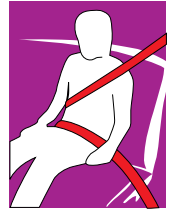

Reserved lanes

Reserved lane signs are placed over or beside lanes to indicate that these lanes are for use by specific vehicles only. The symbol on the sign shows the type of vehicles that are permitted to use the lane. The symbols that may be seen are the silhouettes of a bus, taxi, and bicycle. Reserved lanes that are designated for part time operation will show the hours of the day and the days of the week when that lane is reserved. If a lane is designated for full time use, the sign will not show the times and days. There will be a final sign at the end of the reserved lane to show that the reserved lane ends. The white diamond on a black background indicates that the vehicles in the reserved lane travel in the same direction as the traffic.

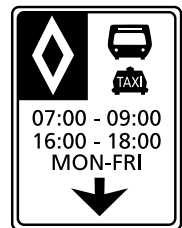

5

Other uses for a Class 4 licence

For hire

A Class 4 licence is required for a driver who is operating a vehicle under the condition for hire, as defined below from the *Operator Licensing and Vehicle Control Regulation*.

For hire with respect to a vehicle, means that the vehicle owner or operator, or the operator's employer, is being paid for the service that the vehicle is being used to provide, but for the purposes of sections 23 (Class 3 licence) and 25 (Class 5 licence), a motor vehicle is not for hire when the operator drives a private passenger vehicle for the transportation of passengers on an incidental or occasional basis and receives compensation in respect of the transportation of those passengers only in one or more of the following forms:

- 1. as payment for the kilometres travelled at a rate not exceeding the limit of tax-exempt allowance paid by employers to employees as prescribed in section 7306 of the Income Tax Regulations of Canada (CRC chapter 945);*
- 2. as straight reimbursement for out-of-pocket expenses directly related to the transportation, including, without limitation, gas, parking, gate passes and tolls;*
- 3. in a case where the operator is party to an agreement to provide transportation to only the operator's family members, members of the operator's household or persons for whom the operator is a legal guardian, as compensation only to provide transportation to those persons.*

Chapter 6

Transporting Dangerous Goods

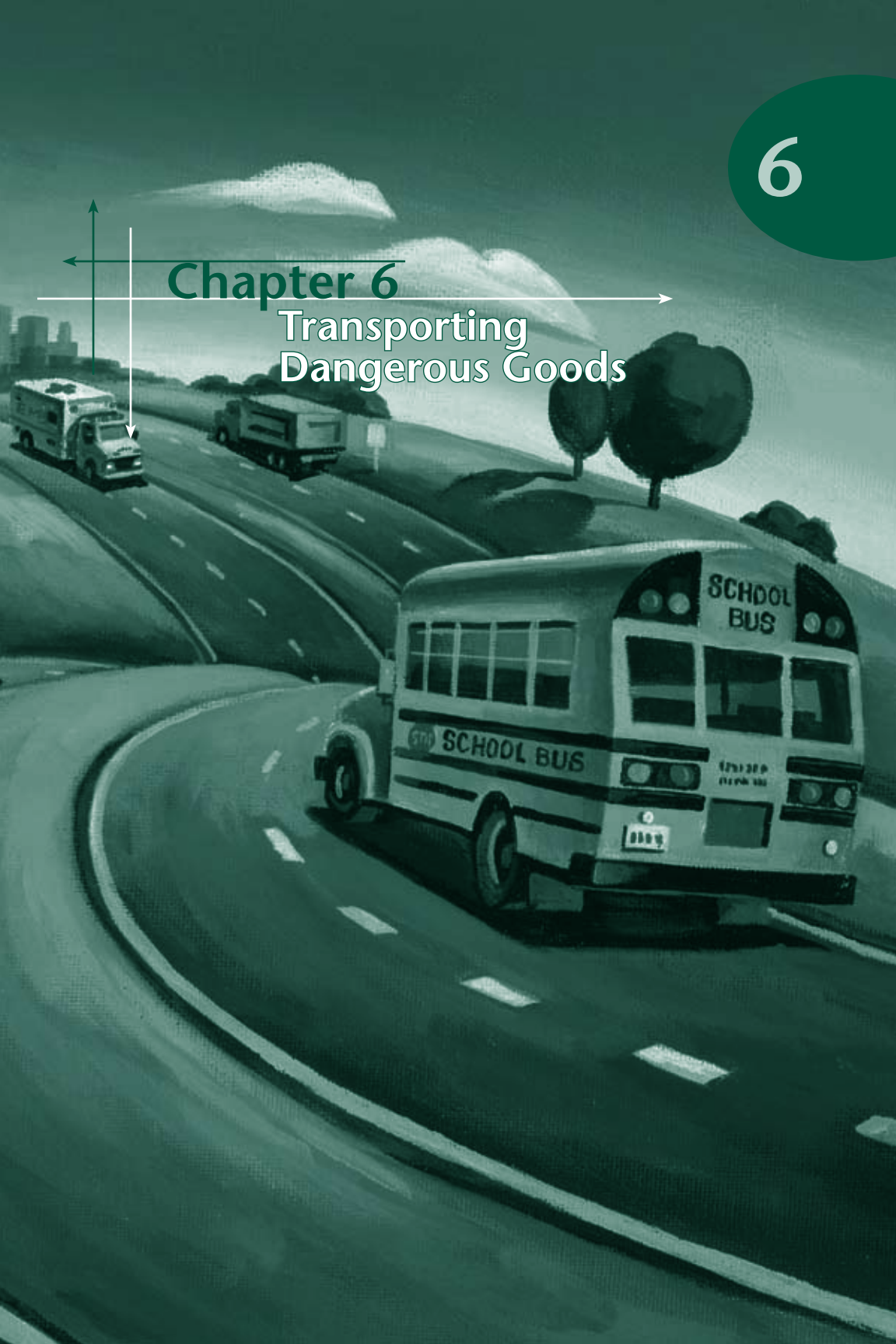

6

Transporting Dangerous Goods

The laws on dangerous goods state that no one shall handle, offer for transport or transport dangerous goods unless they are trained or they work directly with someone who is trained.

Carriers are responsible to make sure their employees have the proper training to work safely with dangerous goods. This usually means a formal in-house training program to earn a Dangerous Goods Training Certificate. This certificate shows that the employee has successfully completed the training. Carriers can provide their own training or may hire someone to do the training for them. However, in all cases, the **employer** must be satisfied with the training, and sign the certificate of training indicating that the driver has successfully completed the dangerous goods course.

A driver of dangerous goods is required by law to produce a certificate of training, if asked to by a dangerous goods inspector.

What is a dangerous good?

There are nine hazard classes of dangerous goods. Within some classes there are divisions.

Class 1:**Explosives**

- 1.1 A substance or article that explodes as a mass.
- 1.2 A substance or article with a fragment projection hazard, but not a mass explosion hazard.
- 1.3 A substance or article that has a fire hazard along with either a minor blast hazard or a minor projection hazard or both, but not a mass explosion hazard.
- 1.4 A substance or article that presents no significant hazard, with explosion effects that are largely confined to the package and no projection or fragments of appreciable size or range are to be expected.
- 1.5 A very insensitive substance that has a mass explosion hazard like those substances in 1.1.
- 1.6 An extremely insensitive substance that can have a mass explosion hazard like those substances in 1.1.

6

Class 2:



Gases

- 2.1 A flammable compressed gas.
- 2.2 A non-flammable, non-toxic compressed gas.
- 2.3 A toxic compressed gas.

Class 3:



Flammable liquids

- 3 A liquid with a closed-cup flash point of less than 60.5 degrees Celsius.

Class 4:**Flammable solids, substances liable to spontaneous combustion, and substances that emit flammable gases on contact with water****4.1 A solid that:**

- ignites easily while it is being transported,
- burns vigorously and persistently, or
- contributes to fire through friction or from heat kept during manufacturing or processing.

4.2 A substance that might spontaneously combust when exposed to air, or might spontaneously heat up to the point where it ignites in contact with air.**4.3 A substance that might emit flammable gas(es) or create enough heat to ignite gas(es) if it comes in contact with water or water vapour.**

6

Class 5:



Oxidizing substances and organic peroxides

- 5.1 A substance that contributes to the combustion of other material by yielding oxygen or other oxidizing substances, whether or not the substance itself is combustible.
- 5.2 An organic compound that has the bivalent “O-O” structure that is a strong oxidizing agent and may be liable to explosive decomposition or is sensitive to heat, shock or friction.

Class 6:



Toxic substances and infectious substances

- 6.1 A solid or liquid that is toxic when:
- its vapours are inhaled,
 - it comes in contact with skin
 - it is ingested.
- 6.2 Infectious organisms or organisms believed to be infectious to humans and animals.

Class 7:**Radioactive materials**

Radioactive materials are not named, only described by activity or package requirements.

Class 8:**Corrosive materials**

Corrosive materials will corrode metal, human skin and internal tissue.

6

Class 9:

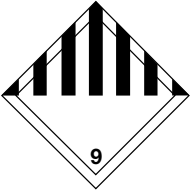

Miscellaneous products or substances

- 9.1 Miscellaneous dangerous goods.
- 9.2 An environmentally hazardous substance.
- 9.3 A dangerous waste.

Dangerous occurrences

A driver who is in charge of, in management of, or in control of dangerous goods when a dangerous incident occurs such as a leak, collision, or an unintentional release or near release, must immediately notify:

- the local police
- Alberta Transportation, Co-ordination and Information Centre (CIC) at 1-800-272-9600
- the owner of the vehicle
- the employer
- the person or company who owns the consignment of dangerous goods.

Documents

Every driver who transports dangerous goods must have a copy of the shipping document, waste manifest or any other of the documents required by law. The documents must be within reach or in a pocket mounted on the driver's door when the driver is in the cab of the truck. When not in the cab, the documents must either be on the driver's seat or in the pocket on the driver's door.

When a parked trailer carrying dangerous goods is not attached to the tractor, the person in charge of the parking area must keep one copy of the documents. If there isn't anyone in charge of the parking area, a copy of the documents in a waterproof container should be attached to the trailer, in a place easily seen and accessible.

When a driver is making more than one delivery of dangerous goods and transporting them by a tank truck, tank trailer or individual gas cylinders, the change in quantity of dangerous goods must be shown on the shipping document. This must be done after each delivery.

Safety marks

Safety marks, when needed, will be supplied by the consignor. A driver who transports dangerous goods has the responsibility to make sure the vehicle has all the proper safety marks, placards, or orange panels on it **before** it is loaded. The safety marks must be placed on each side and each end of a trailer or transport unit.

Placards and panels may be moved to the front of the lead vehicle so the safety marks are visible. The safety marks must stay on the vehicle or large container until no hazard exists. This means the dangerous goods have been unloaded and the container or vehicle cleaned and purged of all residues of dangerous goods.

6

If the dangerous goods placards and panels are lost, damaged, or defaced during the trip, the carrier must replace them.

Note: Every vehicle used to carry Class 1 material, Explosives, must carry a document signed by the owner or the person leasing the vehicle, indicating the name of the driver(s) authorized by this person to operate or accompany the vehicle.

For complete information regarding the transportation of dangerous goods, please call:

Alberta Transportation
Dangerous Goods and Rail Safety Branch
Edmonton 780-422-9600

For toll-free service from anywhere in Alberta, dial 1-800-272-9600,
24 hour service.

Chapter 7

Transporting Persons with Disabilities

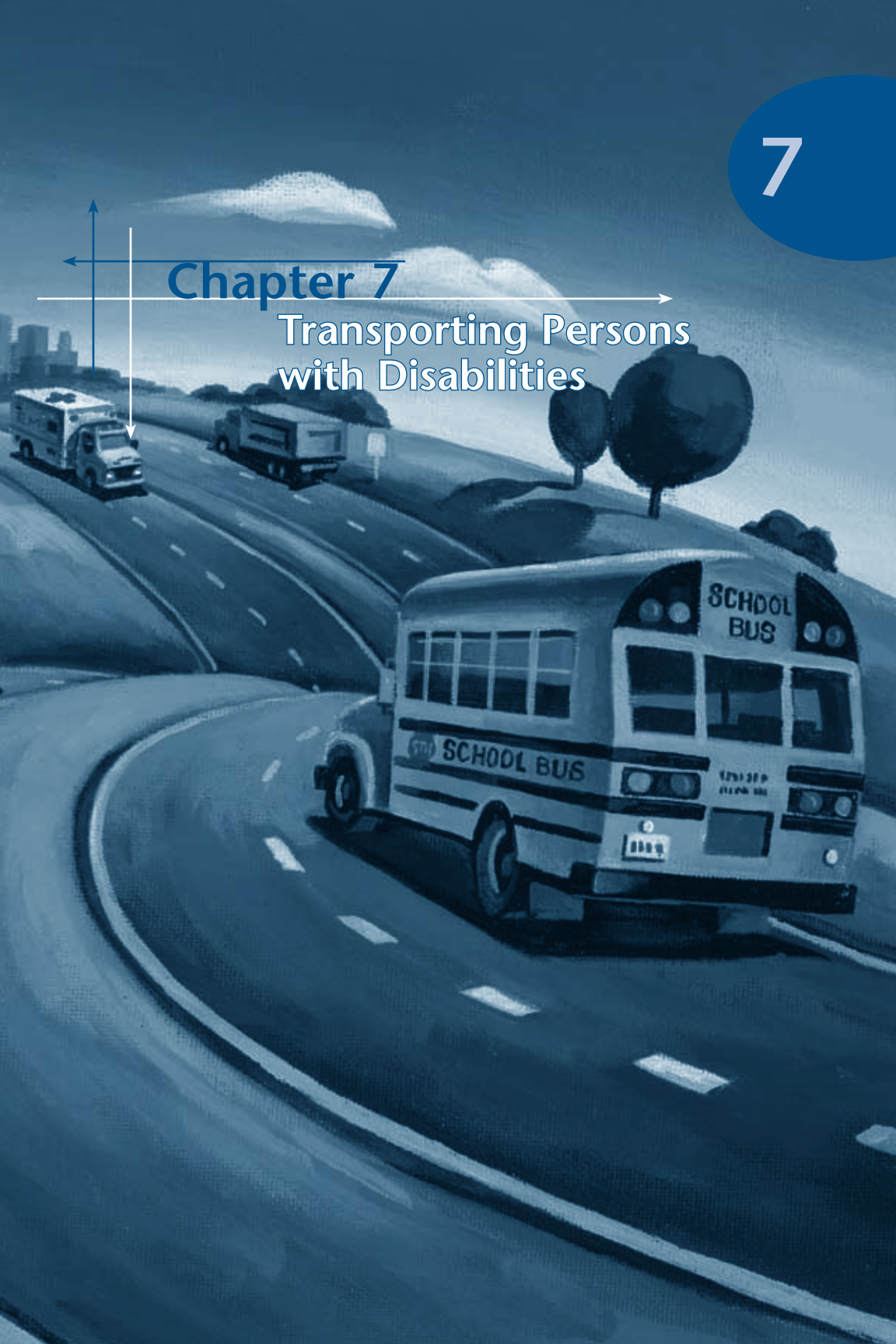

7

Transporting Persons with Disabilities



As a driver of persons with disabilities, you need to be aware of the unique needs of your passengers, who may range from young children to senior citizens. As their needs may be related to thinking, developmental, sensory or physical disabilities, you will want to be familiar with ways you can provide the best customer service for the different disabilities. For example, frail seniors and those with reduced mobility may have health conditions that affect their balance and lead to unsteadiness or falls.

It is also important to be sensitive to your client's personal space. Drivers should recognize that some people may feel uncertain if they are in a new environment.

It is important to communicate with your passengers by responding to the person, not the disability. As disabilities can affect an individual in different ways at different times, never assume you know an individual's needs without first asking. Above all, be patient, courteous and understanding of your client's needs.

General rules for communicating

- Take time to discover each person's preferred method of communicating. Whenever possible, communicate directly with the person with the disability before addressing an attendant.
- When meeting a client for the first time, it is important to review the process that will be followed to transport the individual. This way the client will be reassured and understand what is happening.
- When talking for any significant time to those using wheelchairs or mobility aids, place yourself in front of them, at their eye level.
- Offer people who can walk assistance when it looks like it is needed, but wait until your offer is accepted before you help.
- When assisting people who are visually impaired, it is important you identify yourself. Offer to help by saying something like, "You can take my arm" or "May I help/guide you." If your help is accepted, let the person being guided take hold.
- When assisting passengers who are hearing impaired, gesture with your hand or touch them lightly to get their attention.

7

General rules for driving

- Make sure passengers are properly secured in the vehicle (both seated and wheelchair passengers).
- Drive smoothly, avoiding sudden stops, starts and swerves that may cause passengers to shift or lose their balance. Ease around corners.
- Maintain a comfortable temperature and good air quality and circulation inside the vehicle.
- Keep the noise level in the vehicle, including music or radio, to a level comfortable for your clients.

General rules for assisting a person with a wheelchair

- Ensure that the passenger's feet do not slip from the wheelchair foot rests.
- Push the wheelchair at a normal walking speed. Watch at least three metres (10 feet) in front of you and along the sides of the wheelchair.
- Watch for small cracks or bumps in your path and for other people and objects. Keep your pace slow. Gently tilt the wheelchair over large bumps or cracks.
- Judge distances by the front of the foot pedals rather than the front of the seat.
- Watch for loose handle grips or armrests that are not locked into place.
- Be careful not to bang the wheelchair or handle it roughly. They are not very sturdy and are very expensive.
- Apply the wheelchair brakes when the wheelchair is stopped.

You can find more detailed information regarding transporting persons with disabilities in the document *A Guide for Drivers of Seniors and Persons With Disabilities* at:

www.trans.gov.ab.ca/Content/doctype55/production/pol293.html or by contacting:

Alberta Transportation
Transportation Policy and Economic Analysis Branch
Edmonton 780-427-7944
For toll-free service from anywhere in Alberta, dial 310-0000.

There are special training programs for drivers who transport persons with disabilities, operate air brake equipped vehicles and drive a school bus. You can find out about these programs by contacting:

Alberta Transportation
Driver Safety and Research Branch
Edmonton 780-427-8901
For toll-free service from anywhere in Alberta, dial 310-0000.



Chapter 8

Railway Crossings,
Fire and Fire Extinguishers,
Fuelling A Vehicle

8

Railway Crossings, Fire and Fire Extinguishers, Fuelling a Vehicle

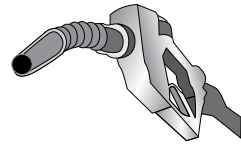
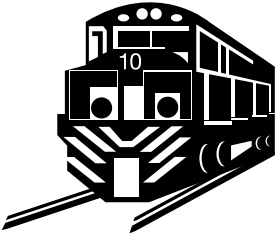

Railway crossings

Crossing railway tracks can be especially hazardous for drivers of large vehicles because of the following.

- Longer vehicles need to travel further and will need more time to clear a crossing.
- Heavier vehicles take more time and need more room to stop before a crossing.
- Larger vehicles that have low ground clearances may cause trailers to get stuck on or displace the tracks.
- Larger vehicles are more likely to derail a train if there is a collision.

The following tips are recommended procedures for railway crossings.

Suggested approach to stopping

- Slow down, shift to a lower gear if you have a manual transmission, and test your brakes.
- Check for traffic behind you and then stop gradually.
- Stop no closer than 5 metres and no further than 15 metres from the nearest rail.
- To better hear a train, roll down the window and reduce any noise inside the vehicle.
- While stopped, look carefully in each direction for approaching trains. Look around obstructions such as mirrors and windshield pillars.
- When waiting, put on your park brakes so that you will not move onto the track.

Resume travel

- Before resuming travel, make sure there is enough room on the other side of the track for the whole unit to clear, including the vehicle's overhang. Be aware that a train will be a metre wider than the rails on both sides.
- Use a gear that will let you cross the track without shifting.
- Check the crossing signals one more time before proceeding.
- If the crossing lights begin to flash after starting, keep going. It is safer to continue than to back up.
- If there is more than one track, there may be more than one train. Do not assume the train you see is the only one.

8

Other considerations

Vehicle stalled or stuck on the tracks

If your vehicle stalls or gets stuck on a crossing, get out of the vehicle immediately. If a train is coming, move away from the track toward the oncoming train. This will reduce the chances of being struck by flying debris if the train hits the vehicle. Contact the railway company if its emergency number is posted or call 911.

Viewing the tracks at a crossing

Do not attempt to cross the tracks unless you can see far enough in both directions to be sure that no train is approaching. Be especially careful at crossings without gates, flashing lights or bells. Even if there are active warning signals, and they do not indicate that a train is approaching, you should still look and listen to be sure it is safe to proceed.

Be cautious when approaching an uncontrolled rural railway crossing at night. A train may be crossing in front of you. The presence of a train may appear like a black, dark object against the background of a dark road.

Vehicle size and clearance

If it won't fit, don't commit. Know the length of your vehicle, the amount of overhang and the amount of space that is available on the other side of the railway crossing. When approaching a crossing, with a STOP sign facing you on the opposite side of the tracks, pay attention to the amount of room there is between the tracks and the sign. Be sure there is enough space to completely clear the railway tracks on the other side.

Railway crossings at rural roads

When you cross railway tracks in rural areas be aware of the following.

- Approach grades may be steeper.
- Snow banks may be higher.
- Brush and trees may be more common.
- There tend to be fewer automated warning systems.
- The grade crossing may be rough or uneven.

Know the law

Controlled crossings

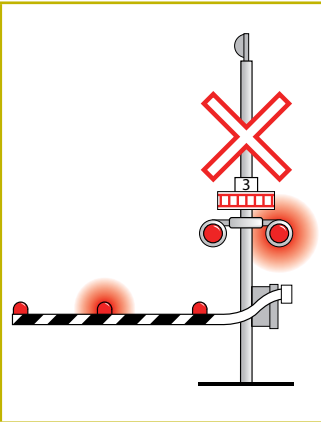

A controlled crossing is one with a flag person, stop sign, crossing gate or an electric or mechanical signalling device. All vehicles are required to stop at controlled railway crossings if signalled to do so.

Uncontrolled crossings

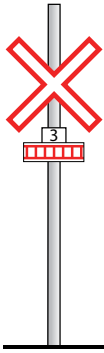

Some vehicles are required by law to stop at all uncontrolled railway crossings. These vehicles are:

- school buses
- vehicles carrying explosives as a cargo or part of their cargo
- vehicles designated for carrying flammable liquids or gas, whether the vehicle is loaded or empty.

If a police officer or a properly identified railway flag person is at the crossing, obey his or her direction as to whether or not to proceed at the crossing. Also, be aware that municipalities may have a bylaw, in addition to provincial regulations, that govern your action of whether or not to stop. This bylaw may apply at any or all railway crossings within their jurisdiction.

Fire and fire extinguishers



A fire can start from several causes. Here are some tips to prevent fires.

- Never start a vehicle that has a fuel leak. Repair the leak and use an approved absorbent material to soak up the fuel spill.
- Shut off the engine when refueling.
- Touch the fuel hose nozzle against the filler pipe of the vehicle tank to ground it before filling. This prevents sparks caused by static electricity.
- Do not smoke near the fuelling areas.
- Check your tire pressure often. Soft tires build heat and can cause a fire.
- Ensure that all your vehicle's brakes are fully released when the vehicle is moving. Dragging brakes generate heat that can ignite grease in the hubs when the vehicle stops.

If you are carrying passengers on a school bus and discover a fire, or danger of fire, stop immediately in a safe location. Get your passengers off the bus and to a safe spot at least 35 metres (about 115 feet) from the vehicle.

Portable fire extinguishers are carried in the driver's compartment in most commercial vehicles. Know what a fire extinguisher can do and how to use it properly.

8

Fire extinguisher operation

Do not try to put out a fire that is beyond your capability or that of the fire extinguisher. Remember, depending on the type and size of the extinguisher, you will have only eight to ten seconds of chemical discharge.

Although there are different kinds and makes of fire extinguishers, they are all used in the same basic way.

- Remove it from its bracket.
- Approach the fire from upwind if possible.
- Hold the extinguisher in an **upright** position.
- Remember the word **PASS**.

The word **PASS** means:

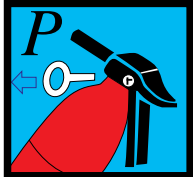
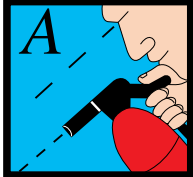
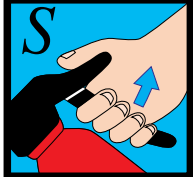
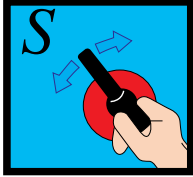
	<p>Pull the pin and point the nozzle away from you.</p>
	<p>Aim low and direct the extinguisher at the base of the fire.</p>
	<p>Squeeze the handle slowly and evenly. Continue to squeeze until the fire is out and/or the fire extinguisher is empty.</p>
	<p>Sweep the extinguisher from side-to-side. Start at one side of the fire and slowly work to the other side. Do not start in the middle of the fire.</p>

Once the fire is out, do the following:

- Replace the safety pin and return the fire extinguisher to its storage compartment.
- Have the extinguisher recharged immediately or replaced.

8

Fuelling a vehicle

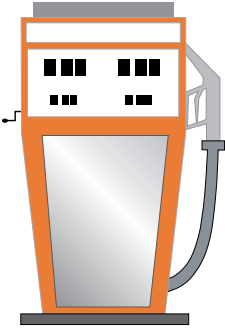

Gasoline or diesel

- Do not add fuel into the tank when the engine is running.
- Never overfill the fuel tank.
- In the event of a major or minor fuel spill, notify the attendant to get it cleaned up immediately using an approved absorbent material.
- Do not add fuel close to electrical sparks or open flame.
- DO NOT SMOKE, and be sure no one around is smoking.
- Do not use a cell phone while fuelling.

Propane

- Only people with the proper certification or training can refuel a propane vehicle or container.
- Ensure there is nothing that could ignite within three metres (10 feet) of the dispenser or container being filled.
- Wear proper protective gloves and clothing, such as a long sleeve shirt.
- Engine and electrical accessories must be switched off.
- DO NOT SMOKE, and be sure no one around is smoking.
- Do not use a cell phone while fuelling.
- Properly attach the filling hose to the vehicle's fuel tank.
- Open the fixed-liquid level gauge (bleeder valve).
- When the fuel level reaches the maximum permitted in the tank, liquid propane in the form of a mist will be discharged from the liquid level gauge. Fuelling should now end.
- The fixed level gauge must be shut off and the fill-line disconnected.
- The magnetic float gauge attached to the tank should indicate that the tank is now filled to capacity. The total capacity of the tank is approximately 80 percent.

